

Structure of microfiche

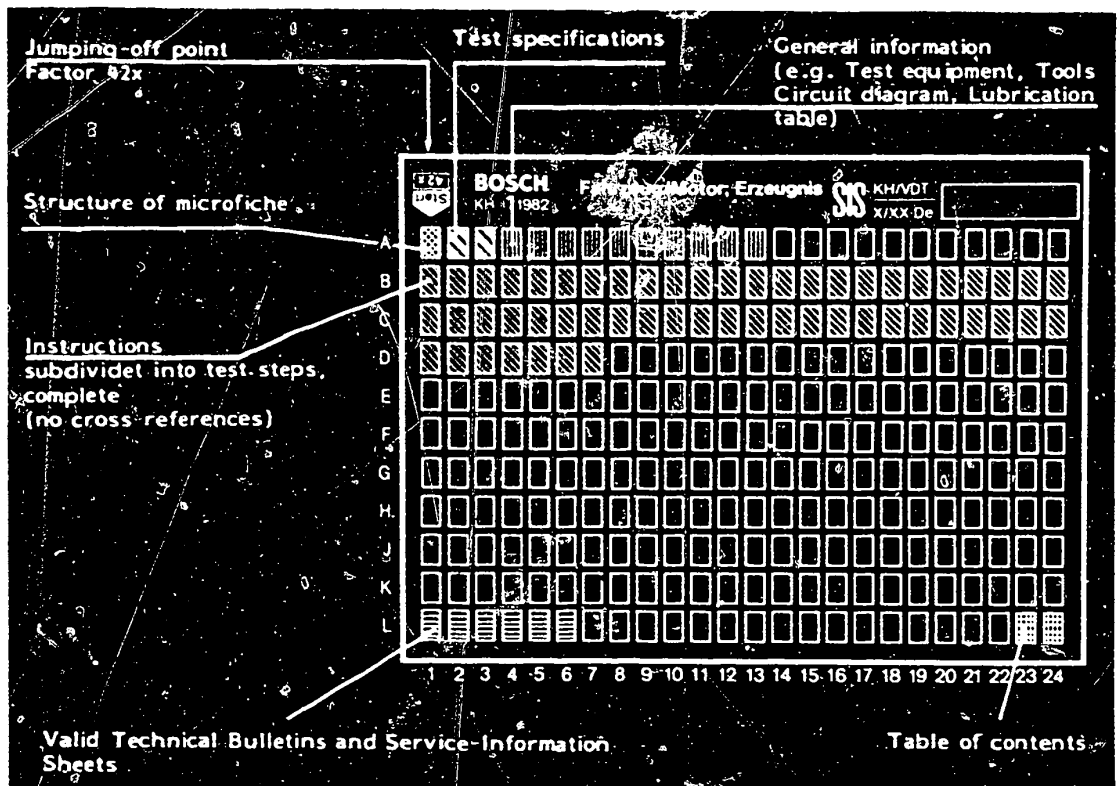

1. Read from left to right

2. Title of microfiche (appears on each coordinate)

E 16	Product/assembly/test step	
	Vehicle/engine	

↑ Coordinate

3. Limits of section



Beginning

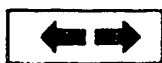

Mid-section



End

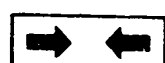

One-page section

4. References to relevant test steps in test specifications; coordinate e.g. C6

C 6

A 1

Trouble-shooting program



1. Electrical test specifications

Coil resistances

B22

<u>Holding winding</u>	<u>Pull-in winding</u>
24 V: 3.28-3.62 Ω	0.513-0.567 Ω
12 V: 0.712-0.788 Ω	0.152-0.168 Ω

C20

Solenoid switch test specifications

Minimum voltage for solenoid switch
with tooth/tooth connection.

24 V switch: ≤ 16.0 V
12 V switch: ≤ 8.0 V

C21

Starting motor test specifications

<u>No-load values</u>	V	A	min ⁻¹	Torque
0 001 420 ...	24	<140	>5500	-
0 001 421 001	12	<200	>5500	-

C24

Short-circuit values

0 001 420 ...	9	<1400	>110 Nm
0 001 421 001	4.5	<2000	> 80 Nm
(with 2 batteries 12V143AH connected in parallel)	5.8	<2600	>110 Nm

A2

Electrical test specifications

KE Stg. motors 0 001 420 ..., 0 001 421...



2. Mechanical test specifications

Commutator diameter new : 50 mm

Minimum commutator diameter : 48 mm

B 13

Brush pressure (per spring) : 47 - 53 Nm

C 9

Min. carbon brush length : 17.5 mm

Armature longitudinal clearance

Commutator end shield
without screw plug

: 0.1 - 0.4 mm

C 10

Armature longitudinal clearance

Commutator end shield
with screw plug

: 0.1 - 0.3 mm

C 14

Backlash

: 0.6 - 0.9 mm

C 22

True-running error

Commutator

: 0.03 mm

Laminated core

: 0.08 mm

B 15

Dimension A

(Relay mounting
bracket/relay dome)

: 62.5 $\begin{matrix} +0.2 \\ -0.5 \end{matrix}$ mm

C 17

A 3

Mechanical test specifications

KE Stg. motors 0 001 420 ..., 0 001 421...

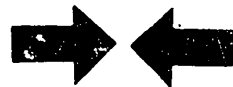

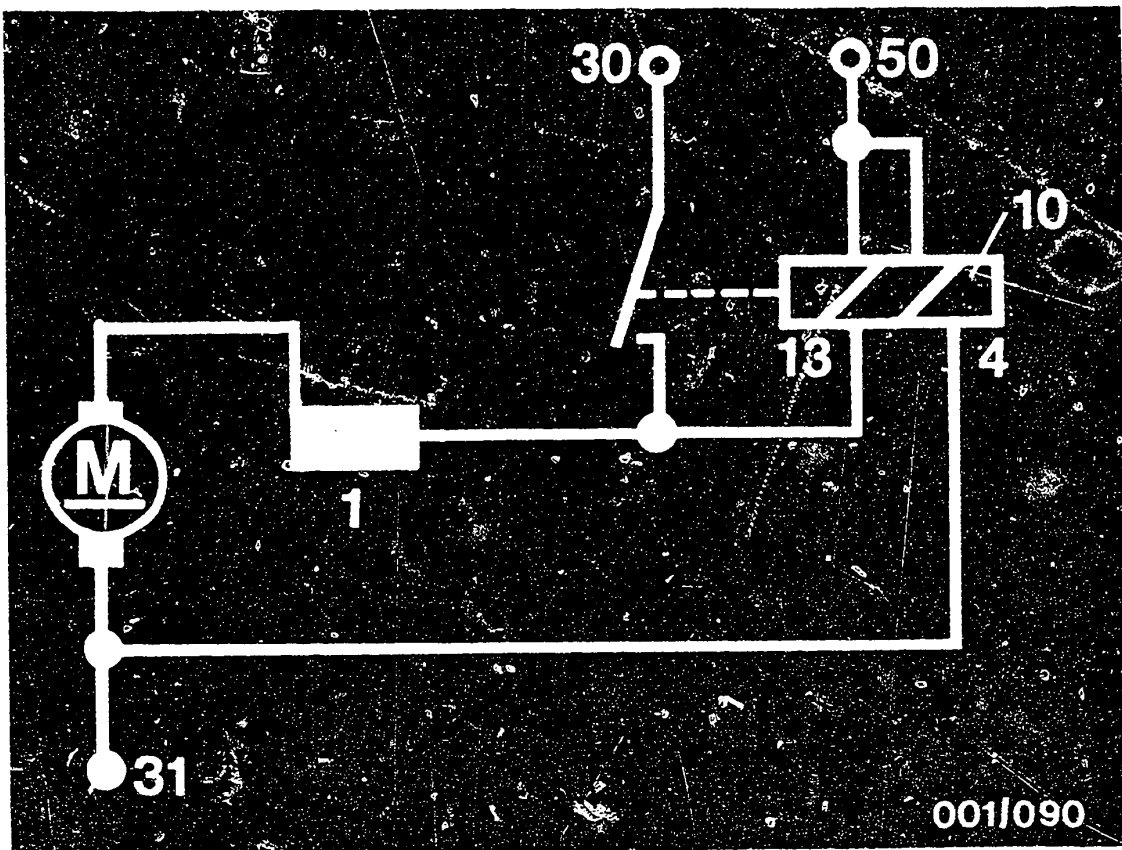

001/090

3. Circuit diagram of starting motor 0 001 420 ...
0 001 421 ...

- 1 = Series winding (excitation winding)
- 4 = Holding winding
- 10 = Solenoid switch
- 13 = Pull-in winding

A4

Circuit diagram

KE Stg. motors 0 001 420 ..., 0 001 421 ...

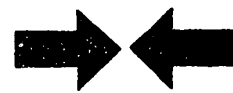

4. General information

The lubricants specified in this manual must be used in order to guarantee satisfactory operation.

Proper repair work is only possible using the specified tools together with measuring instruments which are in proper working order. We advise you, therefore, to use only the tools stated.

All seals and seal rings as well as self-locking micro-encapsulated bolts (relay, commutator end shield) must not be re-used. The 3 needle bushings should likewise be replaced.

All O-rings are to be greased lightly with special lubricating grease 5 932 240 150 before assembly.

A5

General information

KE Stg. motors 0 001 420 ..., 0 001 421 ...



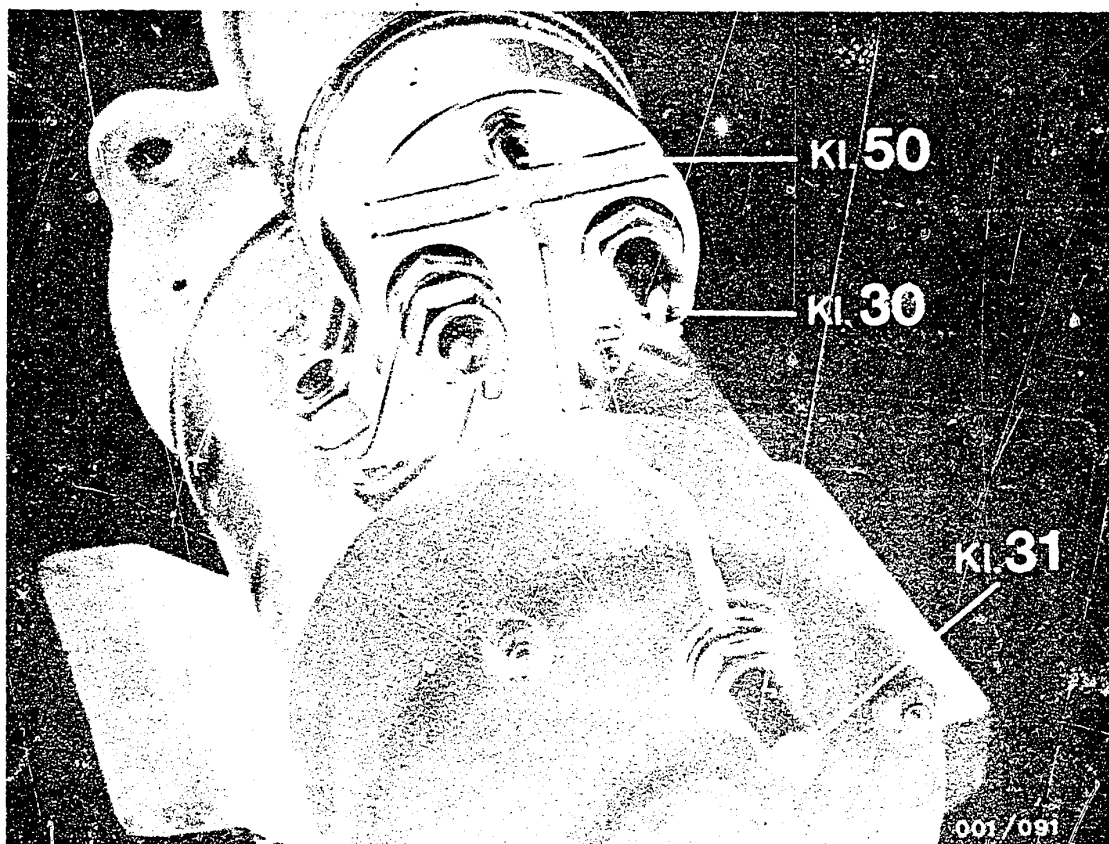

Starting motors 0 001 420 ...
 0 001 421 ...
are insulated from ground (negative).

A6

General information

KE Stg. motors 0 001 420 ..., 0 001 421 ...



Cleaning of parts

Armature, winding, overrunning-clutch drive and relay are to be cleaned only with compressed air (max. 4 bar) and a clean cloth. Do not use liquid cleaning agents.

Other parts, such as bolts and armature shaft, can be washed in commercially available cleaning agent of low inflammability.

Do not breathe in vapours when doing this.

Caution:

Thoroughly dry cleaned parts as gases could subsequently form in a sealed starting motor and there is the danger of an explosion-like detonation.

Observe the following safety regulations:

Decree on working with combustible liquids (VbF) issued by the Federal Ministry of Labour (BmA).

Safety rules for handling chlorinated hydrocarbons
for the workshop

ZH1/222

for the employee

ZH1/119

issued by the Central Association of German Employers' Liability Insurance Associations (Central Association for Accident Prevention and Industrial Medicine)

Langwartweg 103, 5300 Bonn 5.

In countries outside Germany, observe the corresponding local regulations.

A7

General information

KE Stg.motors 0 001 420 ..., 0 001 421 ...



5. Necessary test equipment and tools

Testers

Test bench for 24 V starting motors	EFAL 152
or	EFAL 153
Test bench for 12 V and 24 V starting motors	EFAL 140
only in conjunction with clamping flange	KDAL 5046
Test panel (previously EFAW 81/0681 169 013)	KDAW 9984
Transformer panel (previously EFAW 82/0681 169 014)	KDAW 9985
Interturn short-circuit tester (EFAW 90)	0 681 169 034
or (EFAW 95)	0 681 169 020
Electrics tester ETE 014.00	0 684 101 400
or resistance bridge	Commercially available

Tools

Holding tool (for armature shaft)	KDAL 5036
Measuring tool with dial-indicator insert	KDAL 5037
Press-out mandrel (for commutator end shield with screw plug)	KDAL 5038
Press-out and press-in mandrel	KDAL 5039
Press-in mandrel (intermediate bearing)	KDAL 5040
Press-in mandrel (radial seal)	KDAL 5041
Clamping fixture (relay)	KDAL 5042
Cover flap (for leak test) with 2 test fittings and seal	KDAL 5043
Driving-in mandrel	KDAL 5044
Bearing bushing	KDAL 5045



Necessary tools (continued)

Puller	KDAL 5492
with collet and threaded pin	KDAL 5492/1
Clamping pin in arbor press	KDLI 6010
Tailstock chucks for holding the armature when undercutting the commutator	
with standard cone 2	KDAW 9987
with standard cone 3	KDAW 9990
Spring scale - measuring range 15 ... 50 Nm	KDAW 9992
or measuring range 0 ... 100 Nm	Commercially available
Undercutting saw	KDAW 9998
Clamping support	KDAW 9999
Dial indicator	1 687 233 011
Magnetic instrument stand	4 851 601 124
or	Commercially available
Torque wrench	Commercially available
Arbor press	Commercially available

A9

Necessary test equipment and tools

KE Stg. motors 0 001 420 ..., 0 001 421 ...



6. Lubricants

Special lubricating grease for rolling and plain bearings, pinions, washers, shafts and radial-lip-type oil seals

500 g can (VS 10832 Ft) 5 932 240 150

Anti-corrosion oil

1.0 l can (01 41 v 2) 5 701 351 610

Silicone oil for highly stressed bearings 0.50 l can (VS 13834 01)

5 962 260 605

A10

Lubricants

KE Stg.motors 0 001 420 ..., 0 001 421 ...



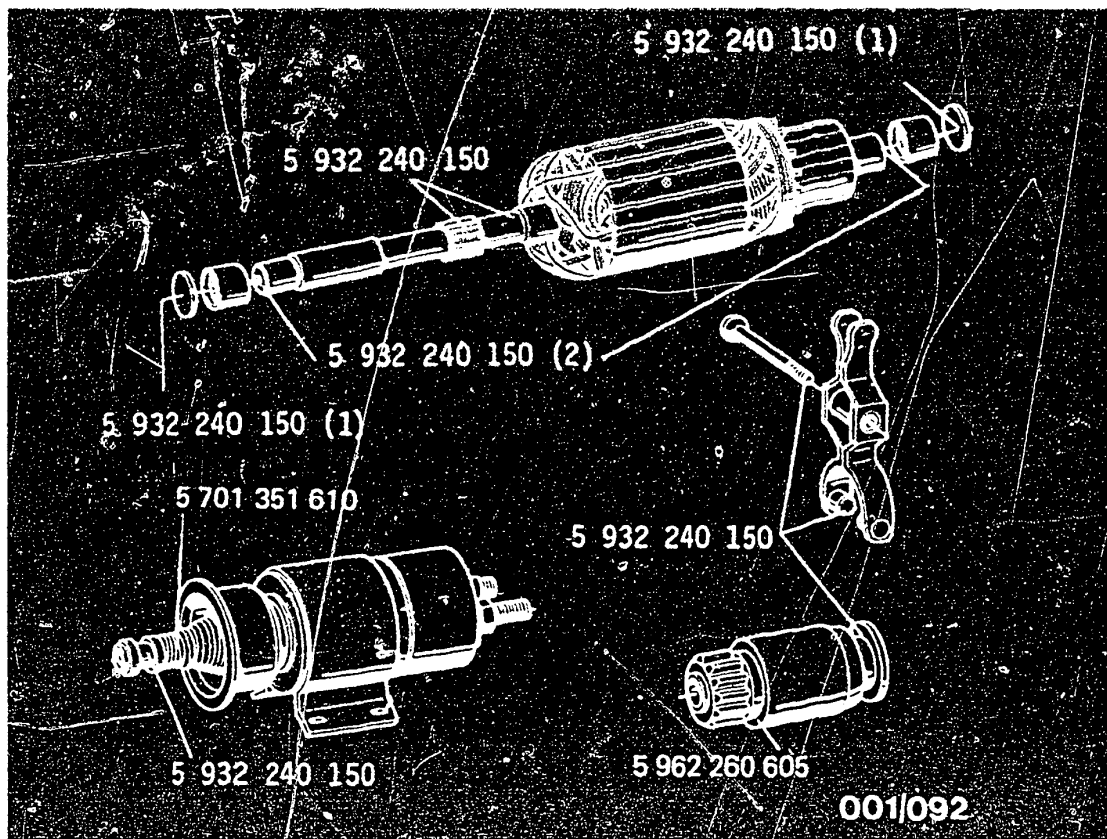

- (1) = Shim plates to be greased on both sides
 (2) = Centering cone to be packed to the brim

6.1 Lubrication table

The commutator must be kept absolutely free of grease and oil.

The stated parts are to be greased or oiled sparingly. Too much grease causes malfunctions at low temperatures. All other bright parts are to be lightly oiled with anti-corrosion oil.

A11

Lubrication table

KE Stg. motors 0 001 420 ..., 0 001 421 ...



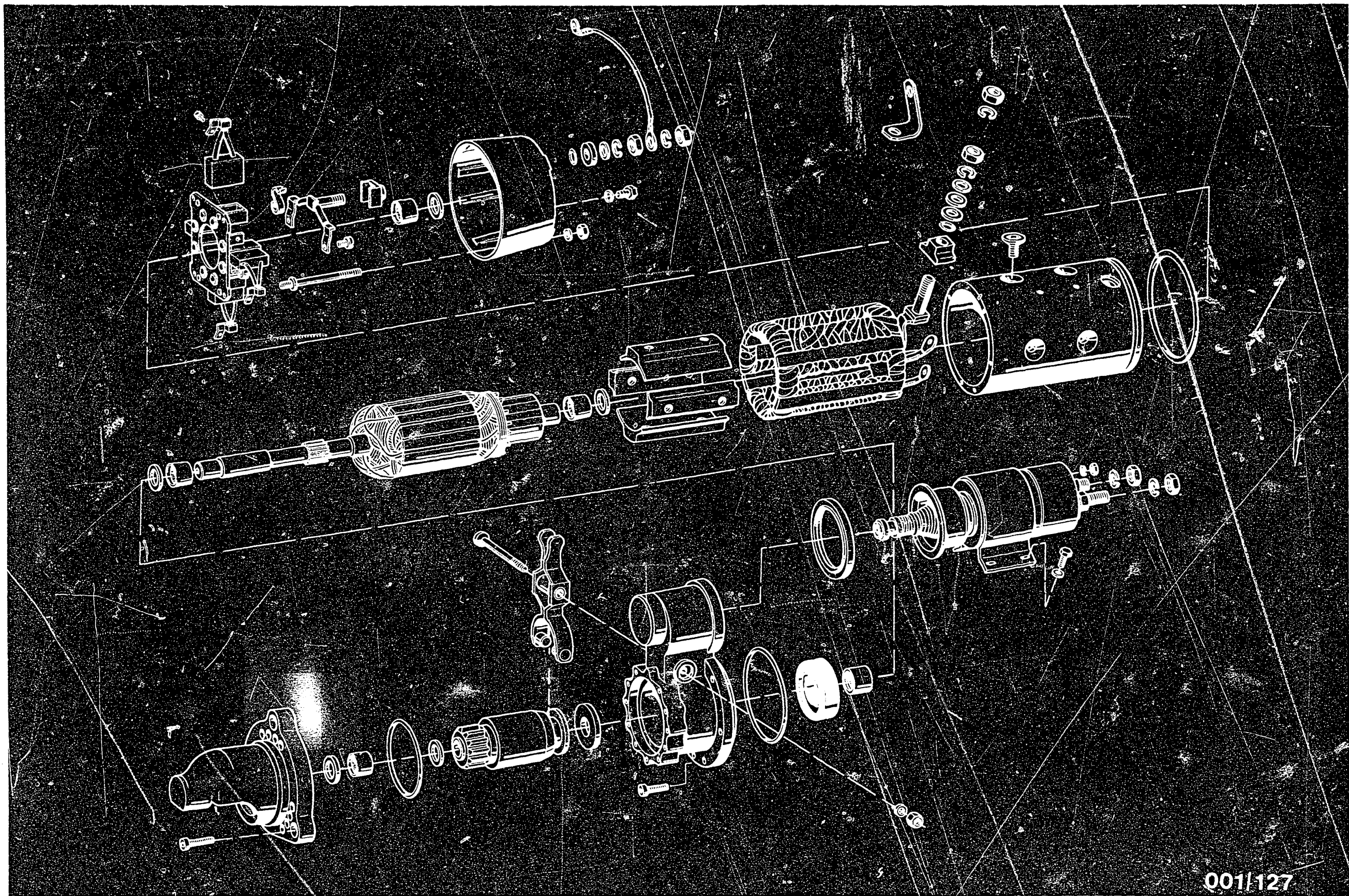

001-127

7. Exploded view

A12

Exploded view

KE Stg.motors 0 001 420 ...,0 001 421 ...



A13

Exploded view

KE Stg.motors 0 001 420 ...,0 001 421...





8. Disassembling the starting motor

Place the starting motor in the clamping support.

Remove bus bar and electric lead (arrows).

B1

Disassembling the starting motor

KE Stg.motors 0 001 420 ..., 0 001 421 ...



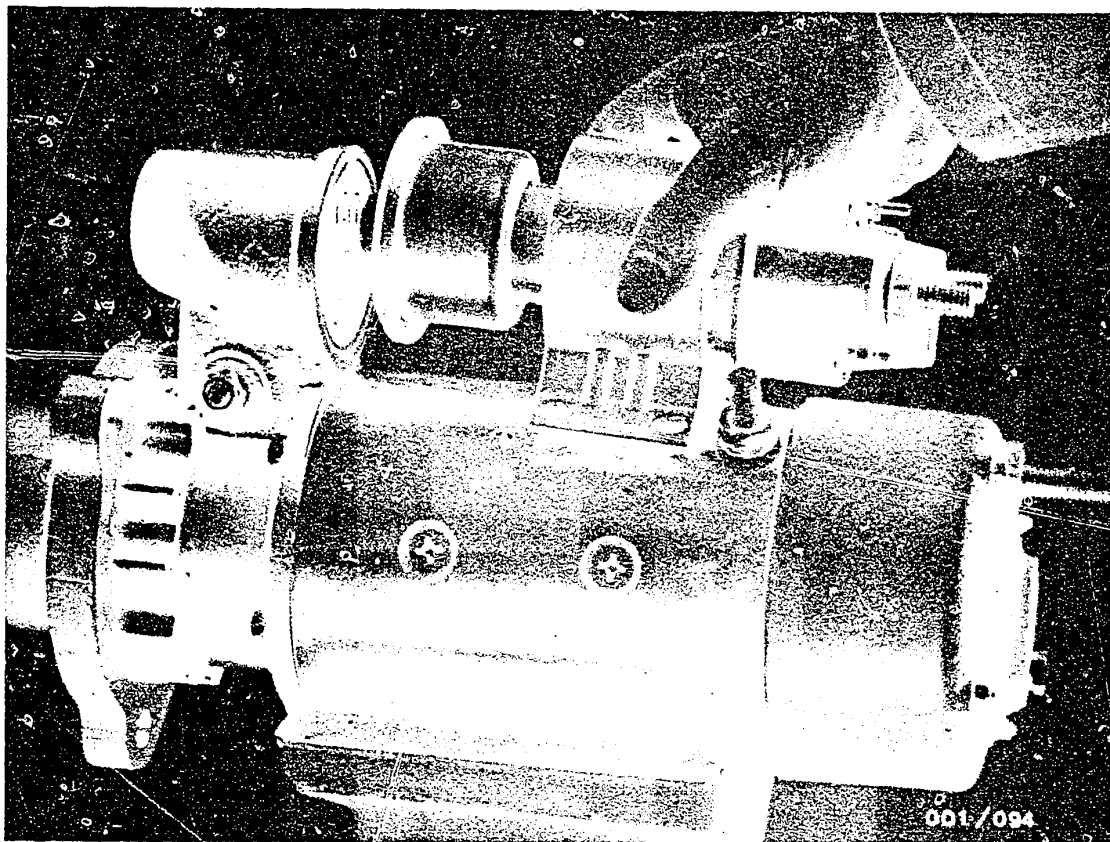

Removing the solenoid switch

Unscrew the solenoid switch from the stator frame, raise slightly and unhook from fork lever.

B2

Disassembling the starting motor

KE Stg. motors 0 001 420 ..., 0 001 421 ...





Removing the commutator end shield

Loosen fastening nuts on commutator end shield.

Pay attention to gasket.

Remove screw plug for armature longitudinal clearance adjustment, if fitted.

Using aluminium or copper bar, carefully loosen commutator end shield by tapping lightly (see illustration).

B3

Disassembling the starting motor

KE Stg.motors 0 001 420 ..., 0 001 421 ...





Removing the carbon brushes

Raise the brush springs using a suitable wire hook and pull out the carbon brushes.

B4

Disassembling the starting motor

KE Stg.motors 0 001 420 ..., 0 001 421 ...





Removing the drive-end-bearing housing

Mark the position of the drive-end-bearing housing/intermediate bearing (see arrow).

Loosen the fastening screws of drive-end-bearing housing.

Using aluminium or copper bar, loosen drive-end-bearing housing from intermediate bearing.

B5

Disassembling the starting motor

KE Stg.motors 0 001 420 ..., 0 001 421 ...



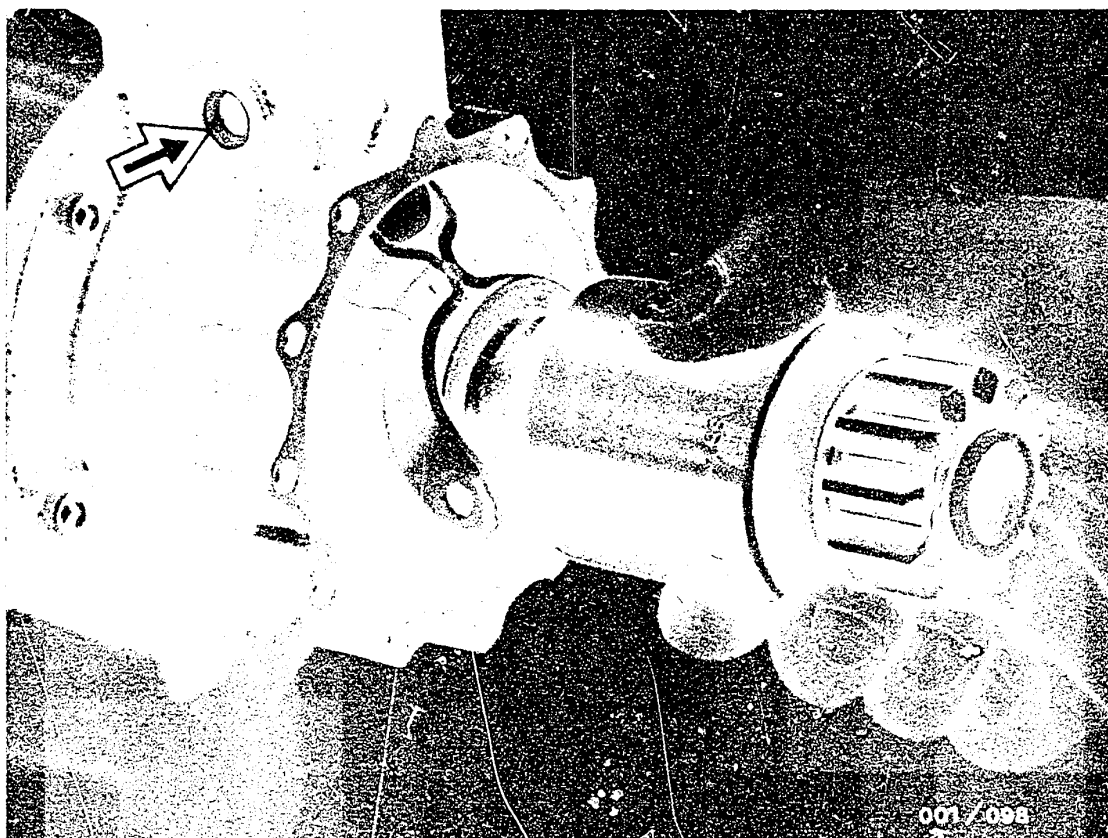

Removing the overrunning-clutch drive

Remove the flat-head screw from the fork lever mounting (arrow).

Remove from the armature shaft the friction washer (steel), overrunning-clutch drive with fork lever and friction washer (intermediate bearing/plastic).

B6

Dismantling the starting motor

KE Stg. motors 0 001 420 ..., 0 001 421 ...



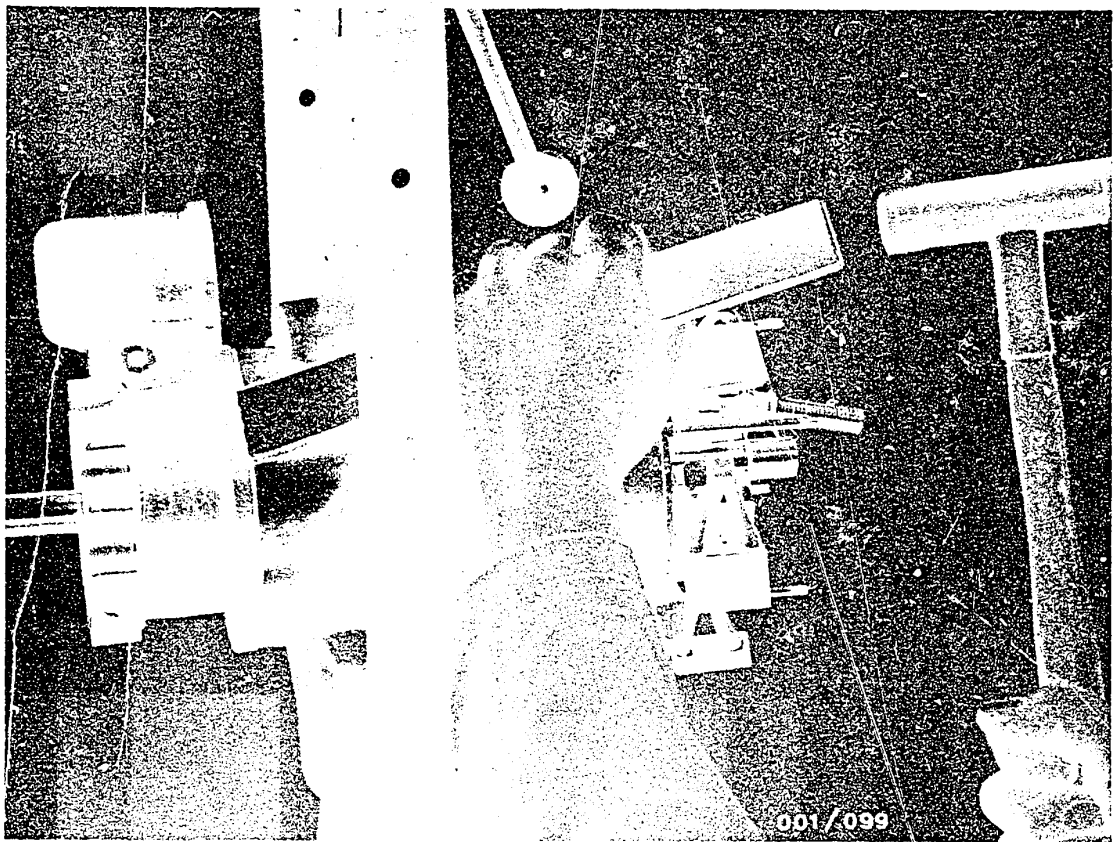

Removing the intermediate bearing

Loosen the fastening screws of the intermediate bearing.

Using an aluminium or copper bar, loosen the intermediate bearing from the pilot of the stator frame (see illustration).

Pull armature out of stator frame.

B7

Dismantling the starting motor

KE Stg.motors 0 001 420 ..., 0 001 421 ...



9. Cleaning of parts

Armature, winding, overrunning-clutch drive and relay are to be cleaned only with compressed air (max. 4 bar) and a clean cloth. Do not use liquid cleaning agents.

Other parts, such as bolts and armature shaft, can be washed in commercially available cleaning agent of low inflammability.

Do not breathe in vapours when doing this.

Caution:

Thoroughly dry cleaned parts as gases could subsequently form in a sealed starting motor and there is the danger of an explosion-like detonation.

Observe the following safety regulations:

Decree on working with combustible liquids (VbF) issued by the Federal Ministry of Labour (BmA).

Safety rules for handling chlorinated hydrocarbons
for the workshop ZH1/222

for the employee ZH1/119

issued by the Central Association of German Employers' Liability Insurance Associations (Central Association for Accident Prevention and Industrial Medicine)
Langwartweg 103, 5300 Bonn 5.

In countries outside Germany, observe the corresponding local regulations.

B8

Cleaning of parts - safety regs.

KE Stg. motors 0 001 420 ..., 0 001 421 ...



Working with inflammable or hazardous substances

Benzine, trichloroethylene and perchloroethylene are approved for washing motor vehicle electrical components which are being repaired. Handle these cleaning agents cautiously in accordance with their degree of danger.

Gasoline, acetone and ethanol are combustible liquids and are explosive when mixed with air. Washing may only take place in special bowls or tanks with a safety lid which closes automatically if the liquid ignites, thus smothering the fire. In the case of larger washing tanks (as of 500 x 500 mm) an extraction system must be provided.

As regards starting motors, reference has already been made in previous repair manuals to the fact that after parts have been washed, particularly when windings have been washed in benzine, they must be thoroughly dried. In the case of sliding-gear starting motors the first start after washing must take place on the test bench without the closure cap being fitted in order to prevent detonations.

B9

Cleaning of parts - safety regs.

KW Stg. motors 0 001 420 ..., 0 001 421 ...



Trichloroethylene and perchloroethylene are liquids whose vapours have the effect of an anaesthetic and are hazardous to health if inhaled over long periods. Trichloroethylene vapours are heavier than air and there is, therefore, increased danger near floor level. Protective goggles and gloves should be worn when handling these liquids.

Cleaning work with trichloroethylene at regular intervals or continuously may only be carried out in special tanks with the extractor switched on. Avoid bending over the tank when washing the components.

B 10

Cleaning of parts - safety regs.

KE Stg. motors 0 001 420 ..., 0 001 421 ...



10. Examination and repair

10.1 General

Examine all parts for wear and damage. Replace worn or damaged parts.

Micro-encapsulated bolts and nuts/seals which have already been used must not be re-used.

Before and during assembly, lubricate the starting motor in accordance with the lubrication table. Where necessary, lubrication points and lubricants are stated in the text. In addition, there is a complete lubrication table on Coordinates A 11 - A 13.

B11

Examination and repair

KE Stg. motors 0 001 420..., 0 001 421 ...



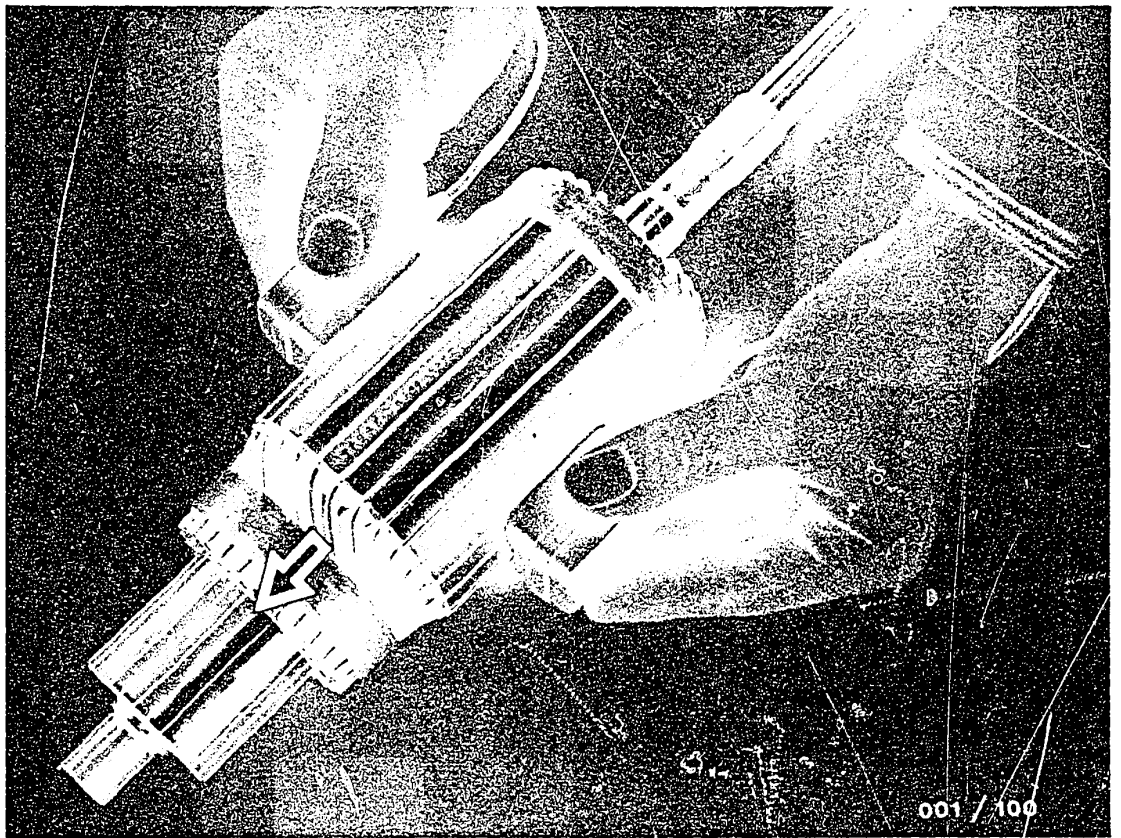

10.2 Testing the armature

Test the armature for interturn short circuit with tester 0 681 169 034 or .. 020 (see illustration).

Test for short circuit to ground with tester KDAW 9984 and 9985.

Test voltage: 80 V for 24 V starting motors
40 V for 12 V starting motors

Watch for possible open circuit
(individual laminations are black - arrow)



10.3 Turning down and sawing out the commutator

When the armature is removed, turn down the commutator if necessary (if worn points are visible).

Burns point to an open circuit in the armature winding - armature must be replaced.

Clamp the armature at the commutator end shield and drive-end-bearing housing ends. Do not damage the armature shaft when doing this.

Pre-turning:

We advise the use of a carbide tool.
Turn down the commutator until worn points are no longer visible.

Minimum commutator diameter: 48 mm.



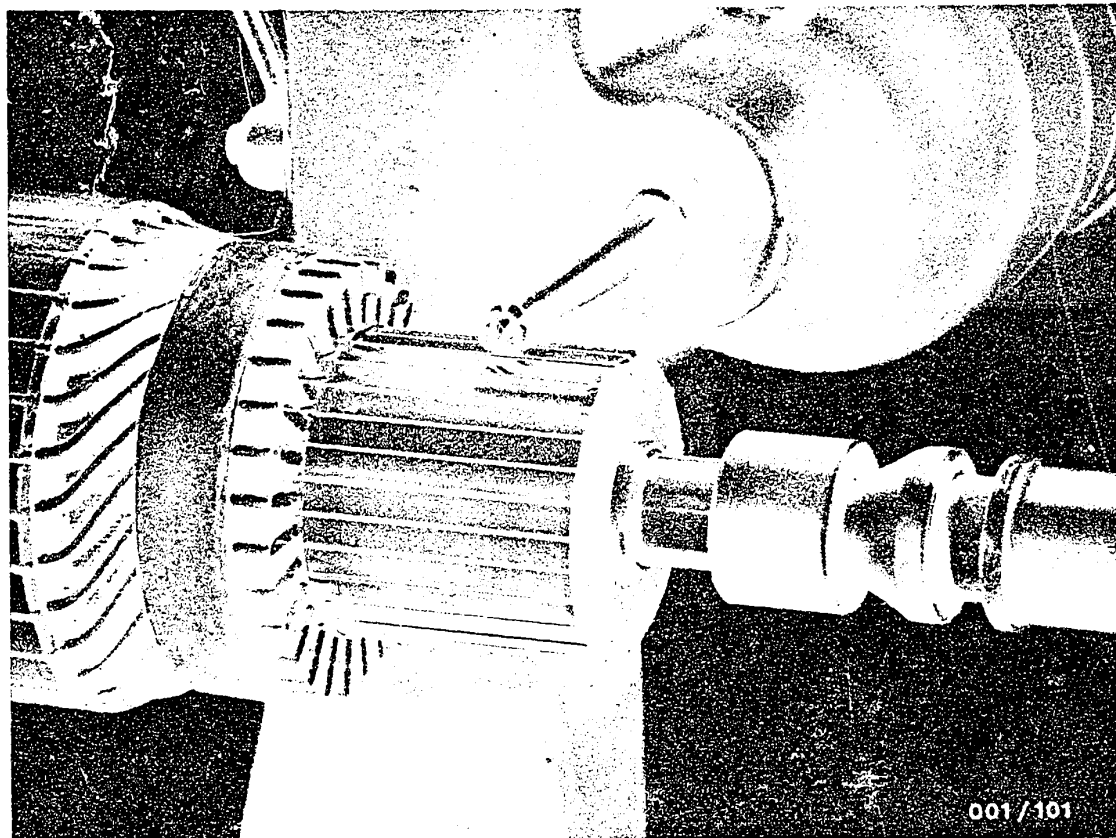

Sawing out and finish-turning the commutator

Clamp the armature in the support of the undercutting saw KDAW 9998. Saw out the insulation between the laminations 0.8 mm deep.

Note:

The insulation between the commutator laminations contains asbestos and the dust which is released must be extracted. Health hazard.

Finish-turning:

Clamp the commutator in the lathe again and turn down with a fine turning tool.

Turning chips may be no more than 0.03 mm thick.

After finish-turning, brush out the commutator with a clean brush free of oil and grease.



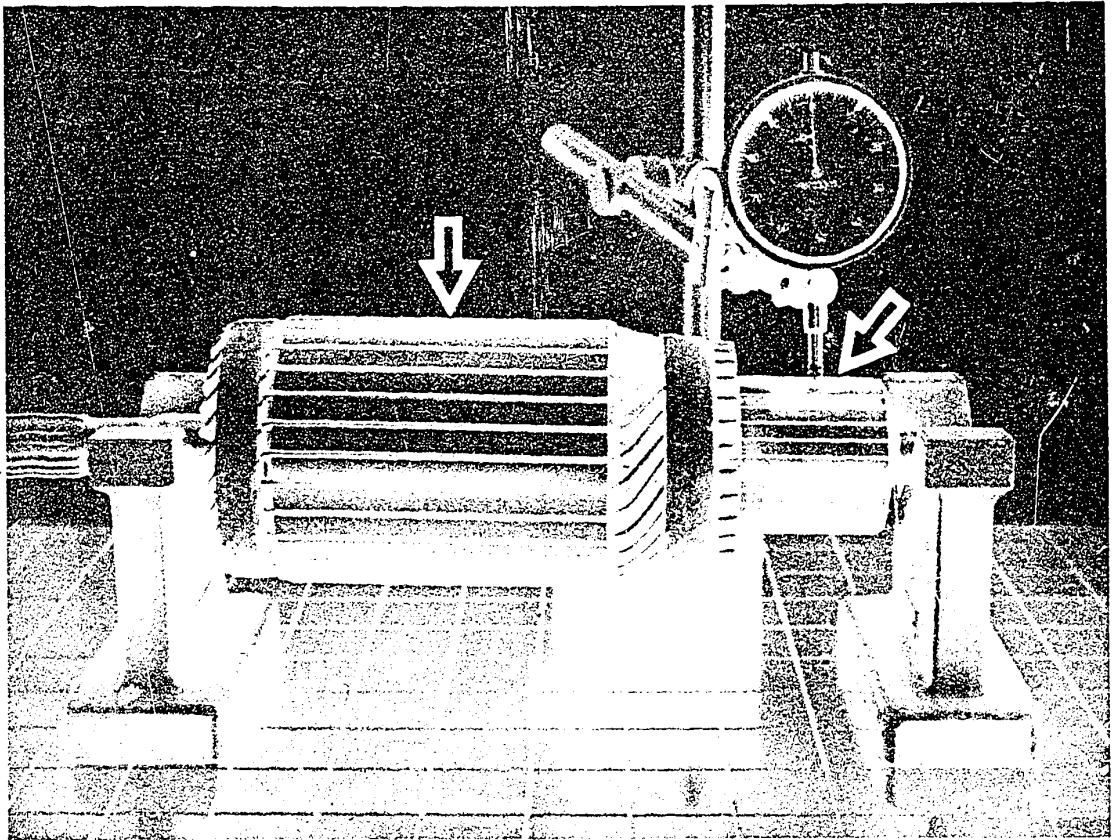

10.4 Checking the true running of the armature:

Commutator ≤ 0.03 mm
Laminated core ≤ 0.08 mm

Check the winding bandages for damage.



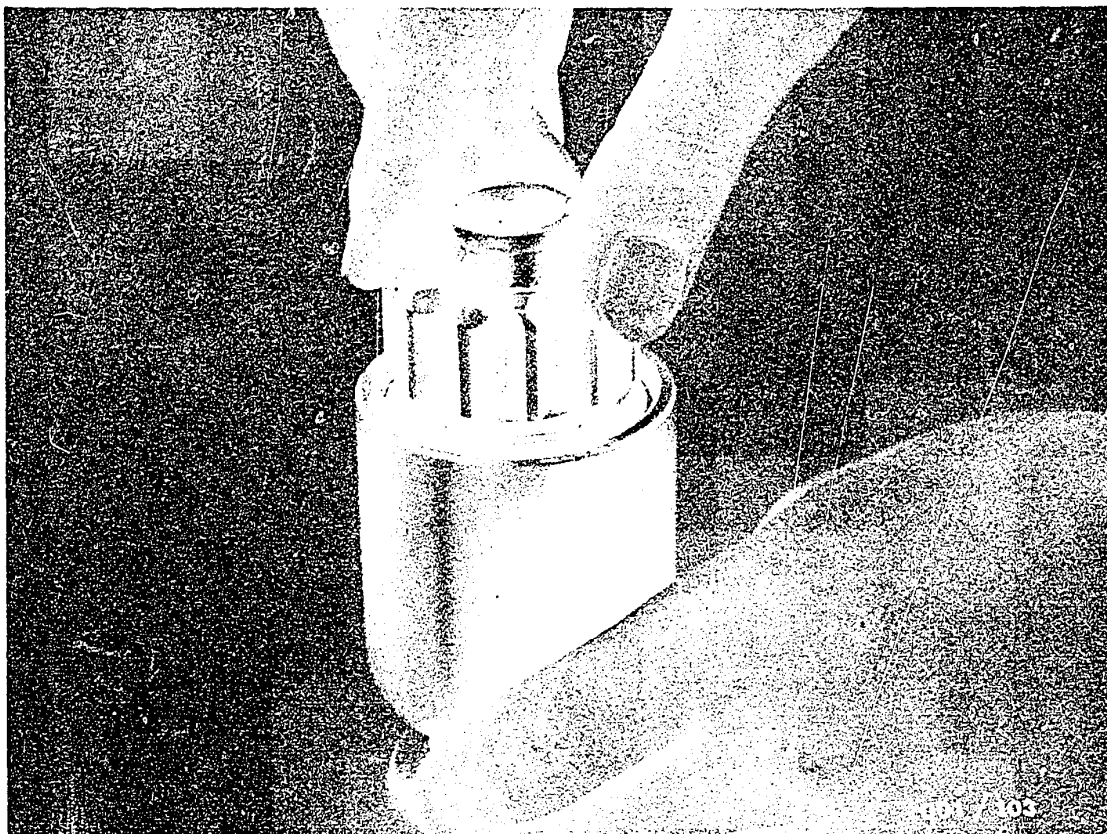

10.5 Checking the overrunning-clutch drive

Visual examination

Surfaces must be free from damage - pay particular attention to pinion and driver.

Functional test

- Hold housing and turn pinion in working direction. The clutch teeth must indicate the overrunning function by an audible ratchet noise.
- Hold the housing and turn the pinion in the opposite direction - locks and will not move.
- Hold the housing and press the pinion into the housing as far as it will go. After being released, the pinion must spring back into its original position (see illustration).



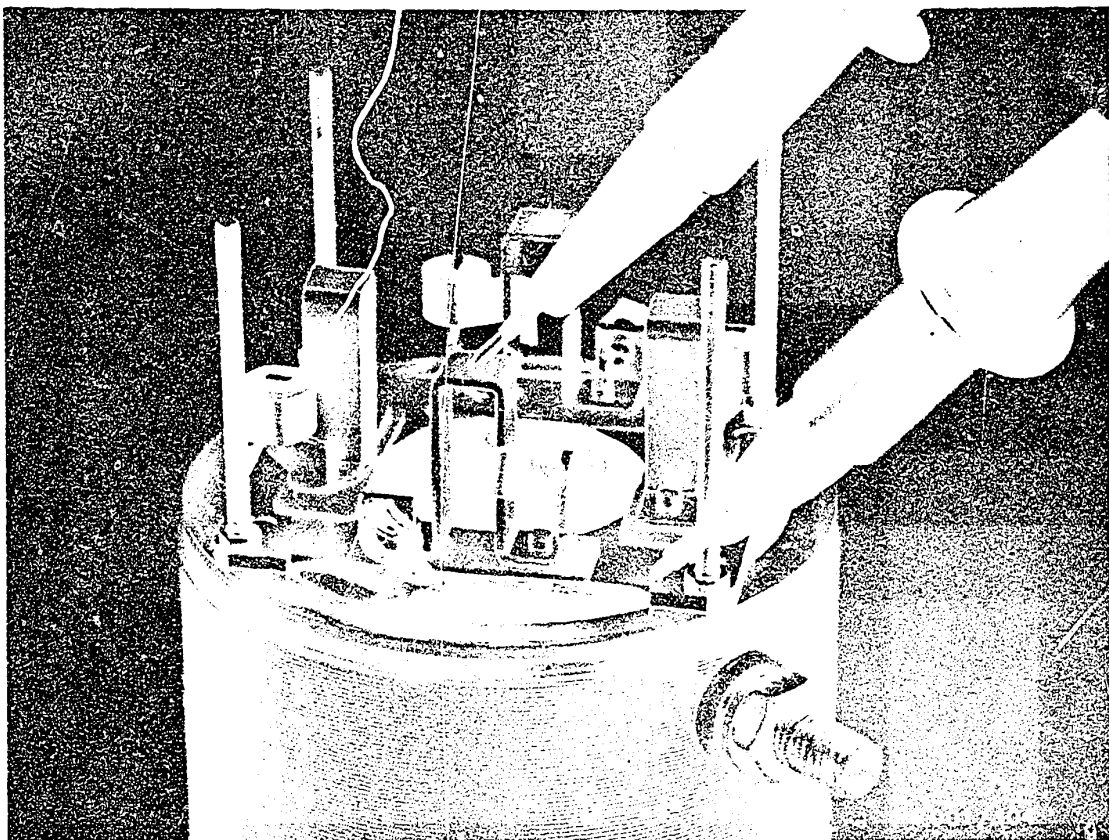

10.6 Checking the brush holders

Unscrew the carbon brushes and electric lead.

Test insulated brush holders for short circuit to ground.

Tester KDAW 9984 and KDAW 9985. Test voltage 80 V.

Check spiral springs for carbon brushes.
Replace spiral springs if damaged or burned.



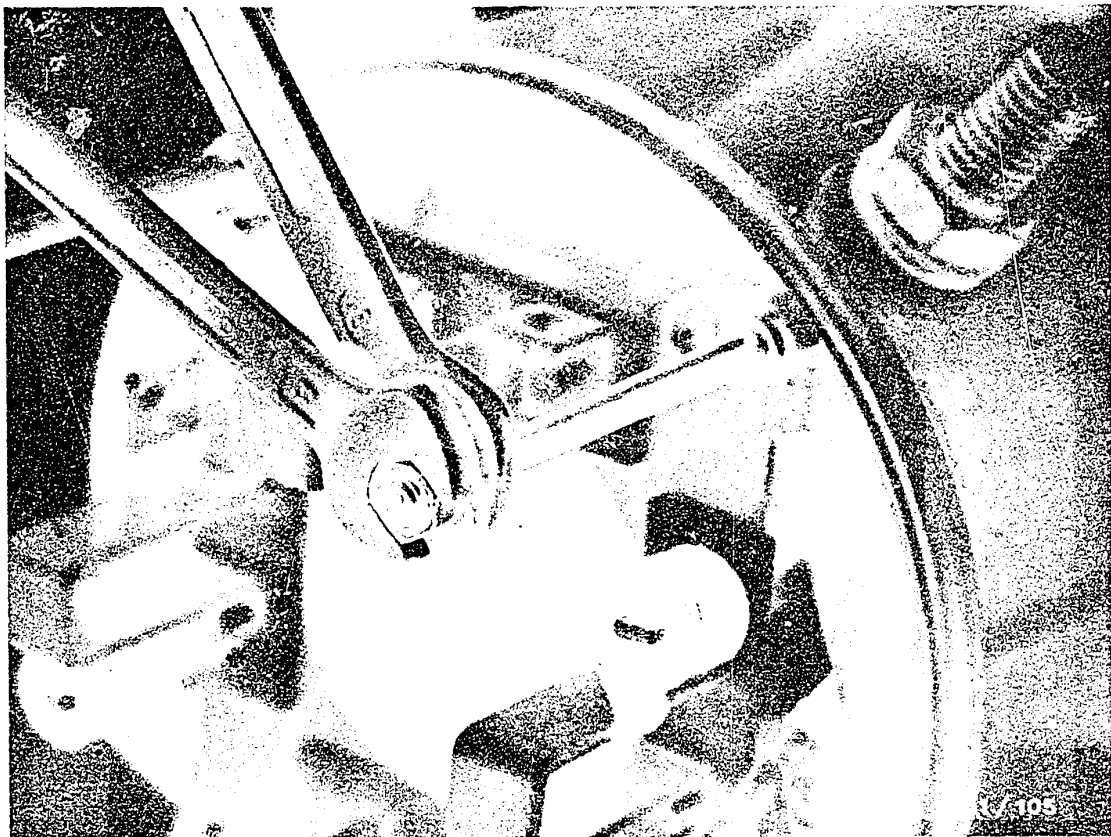

Removing the brush holder

Loosen the threaded pin of the brush holder with two locked nuts.

B 18

Examination and repair

KE Stg. motors 0 001 420 ..., 0 001 421 ...



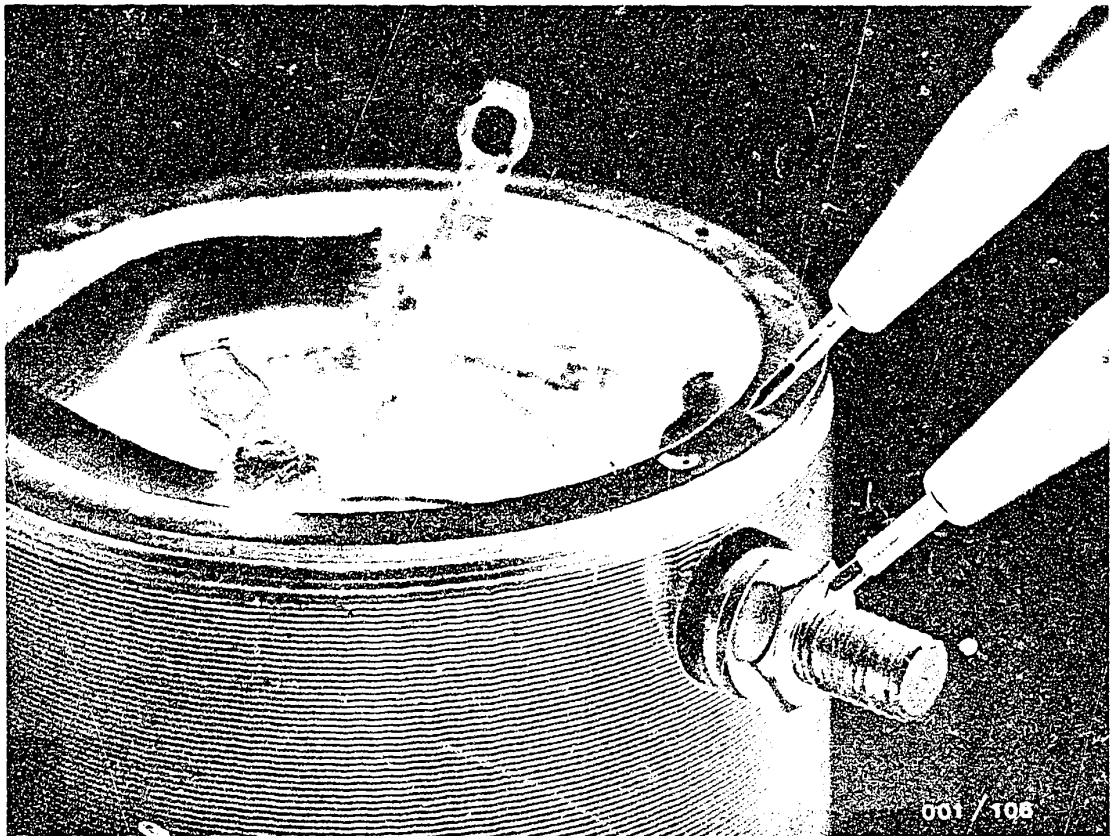

10.7 Testing the stator frame with excitation winding

Test the excitation winding for an open circuit using tester KDAW 9984 and KDAW 9985.

Test voltage: 6 V d.c.

Test for short circuit to ground (see illustration)

Test voltage: 80 V for 24 V starting motors

40 V for 12 V starting motors



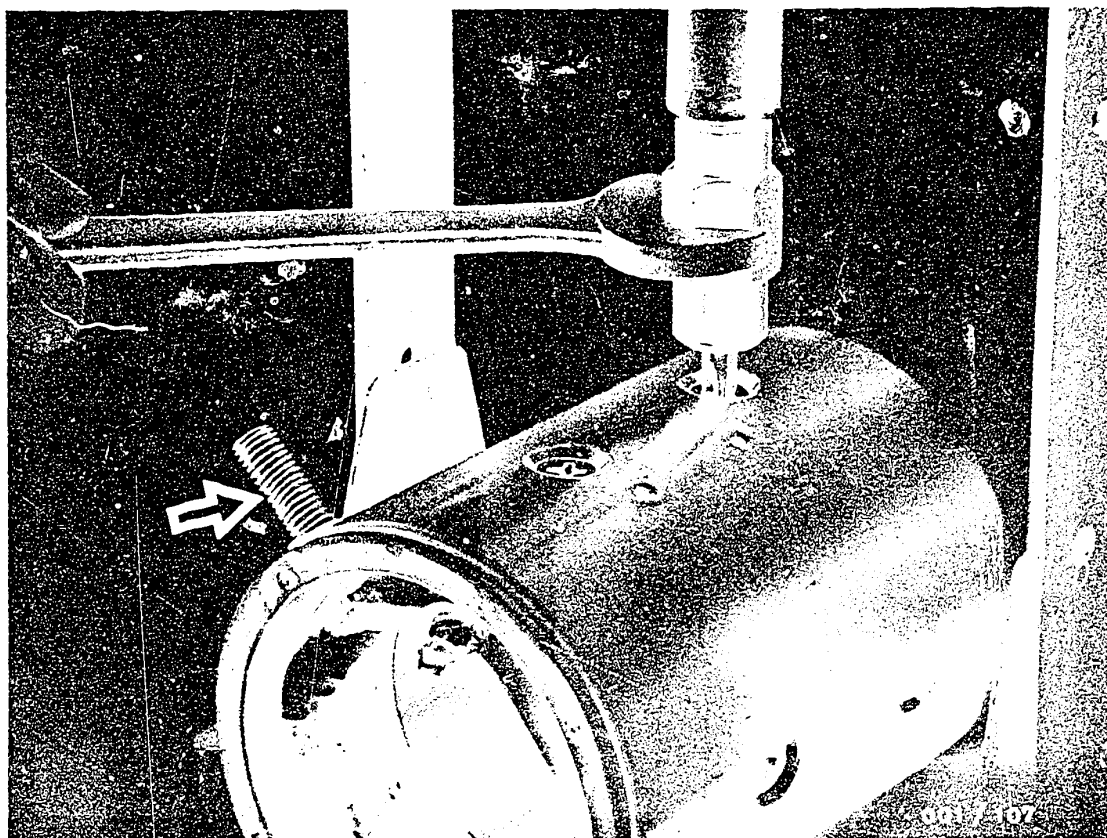

Removing the excitation winding

Mark the position of the pole shoes. Place the stator frame in the clamping support. Remove nut from excitation winding bolt (arrow) and remove pole-shoe screws. Remove windings together with the pole shoes.

B 20

Examination and repair

KE Stg. motors 0 001 420 ..., 0 001 421 ...



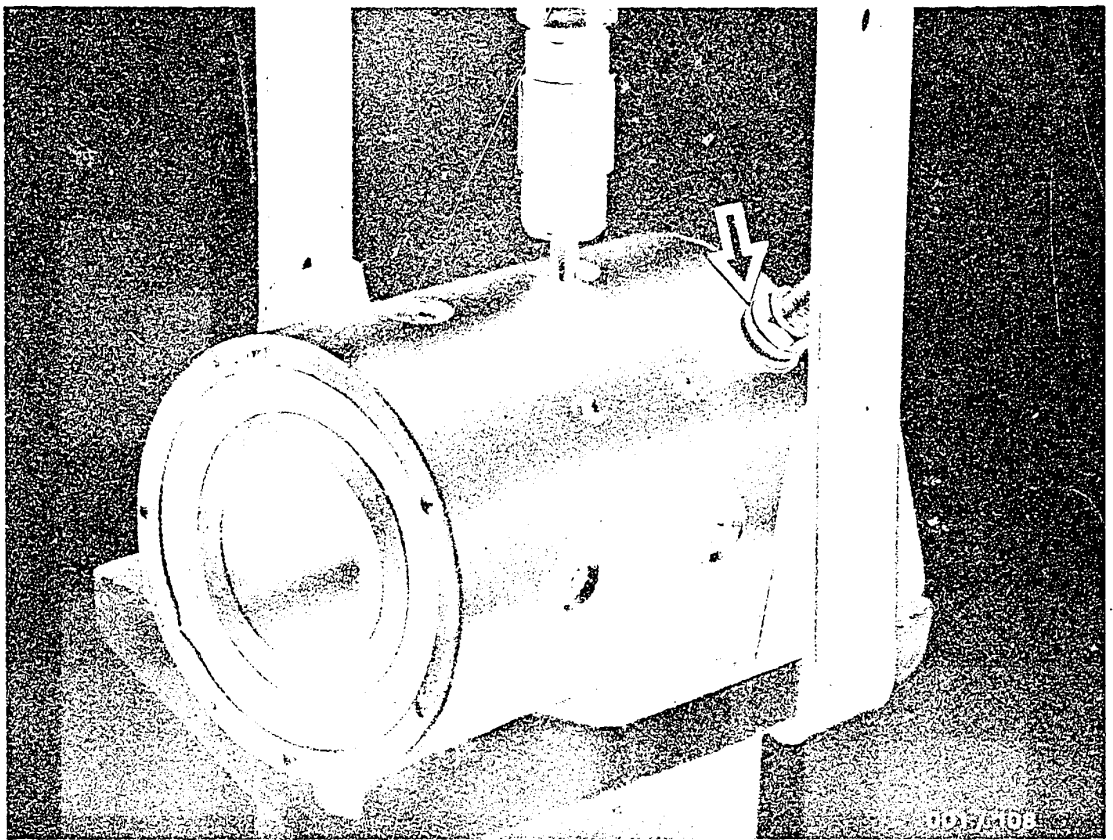

Installing the excitation winding

Heat up the excitation winding slightly, introduce with pole shoes into stator frame (pay attention to marking) and screw down lightly.

Press in the driving-in mandrel with arbor press.

Place the stator frame in the clamping support and tighten the pole-shoe screws. Tightening torque 48-64 Nm.

Mount the insulating washers and nut of the excitation winding bolt (arrow). Tightening torque 25 Nm.

Press out the driving-in mandrel with arbor press.

When installed, test the winding once again for short circuit to ground and open circuit.



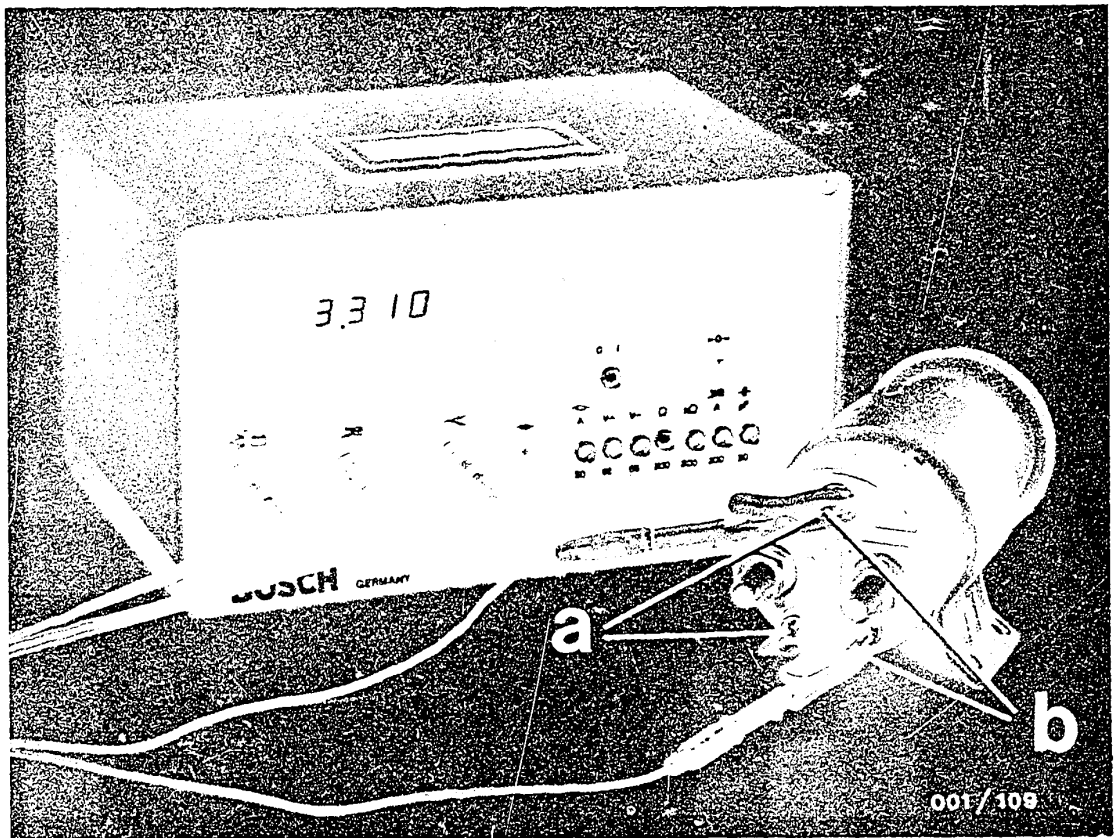

a = Pull-in winding.
b = Holding winding

10.8 Testing the solenoid switch

Check for damage.

Test the resistance of the holding winding and pull-in winding (with electric tester ETE 014.00)

Holding winding	Pull-in winding
24 V: 3.28-3.62 Ω	0.513-0.567 Ω
12 V: 0.712-0.788 Ω	0.152-0.168 Ω

In case of functional testing, apply voltage to the pull-in winding for max. 4 seconds and to the holding winding for max. 90 seconds.



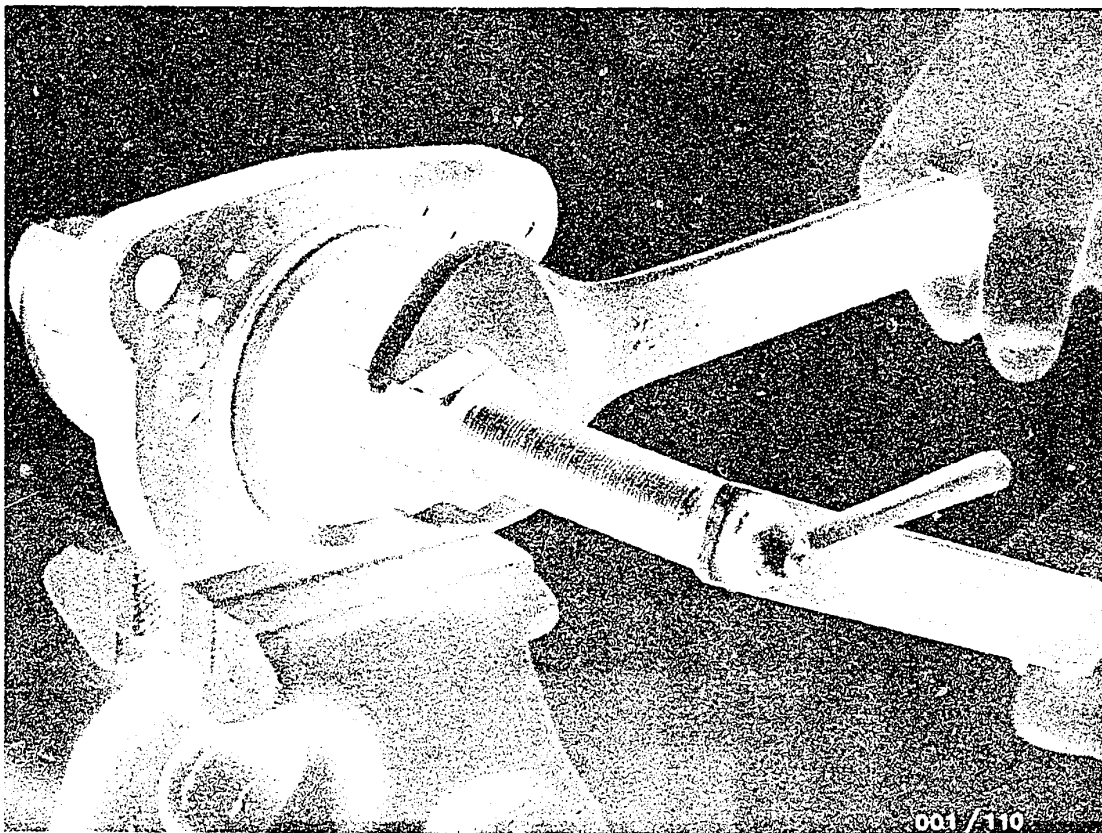

10.9 Removing the needle bushing - drive-end-bearing housing

Note: Do not replace the needle bushing in the commutator end shield until after testing the armature longitudinal clearance.

Extract the needle bushing in the drive-end-bearing housing using puller KDAL 5492 (see illustration).

B23

Examination and repair

KE Stg.motors 0 001 420 ..., 0 001 421 ...



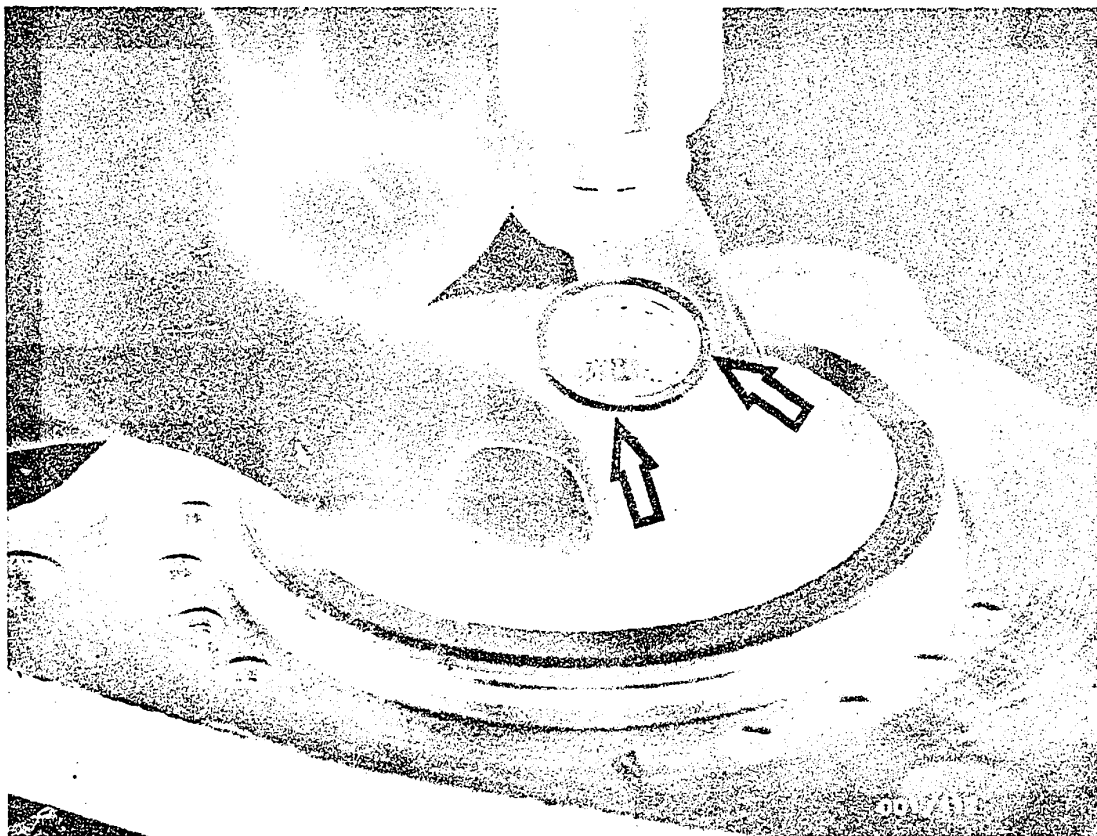

Installing the needle bushing - drive-end-bearing housing

Check the 2mm shim plate (23.8 mm diameter) for damage and replace if necessary.

Fit the needle bushing onto the press-out and press-in mandrel KDAL 5039 (lettering on needle bushing must point upward towards press-in tool, see illustration, arrows).

Press in the needle bushing until the tool (KDAL 5039) comes up against the drive-end-bearing housing.



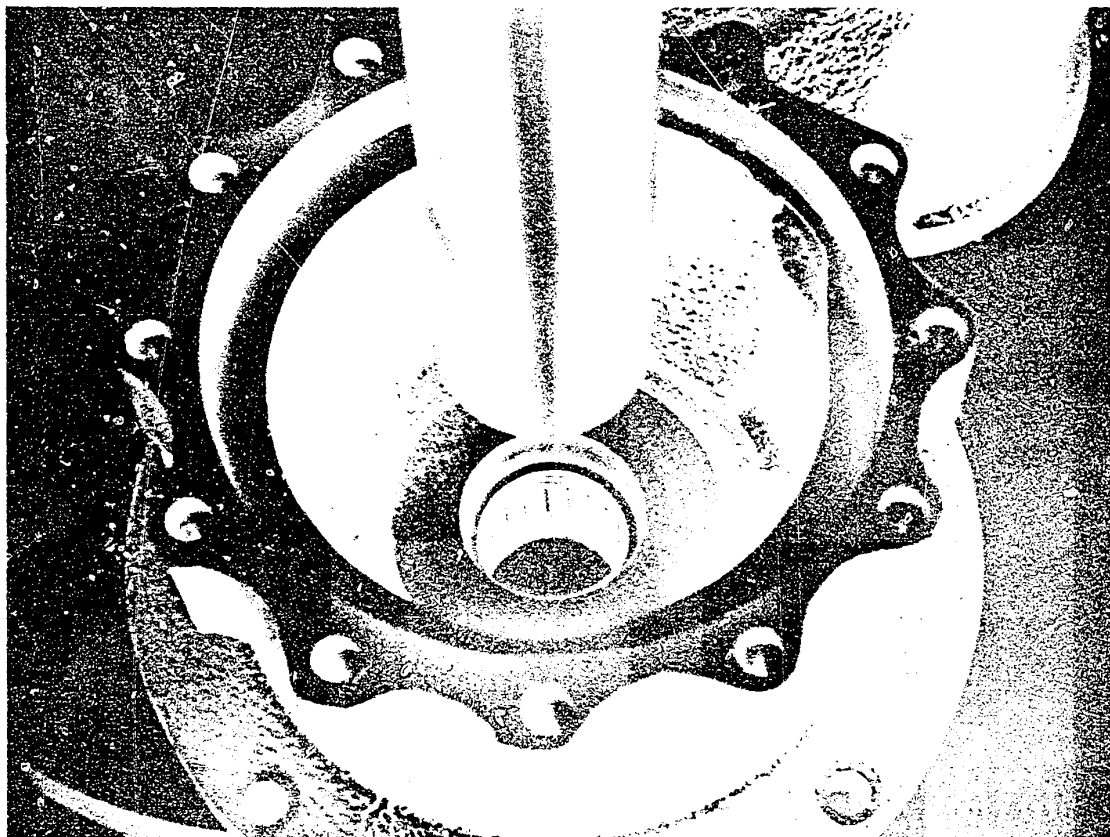

Removing the needle bushing - intermediate bearing

Force out the needle bushing of the intermediate bearing and the radial-lip-type oil seal using press-out and press-in mandrel KDAL 5039.

C1

Examination and repair

KE Stg.motors 0 001 420 ..., 0 001 421 ...



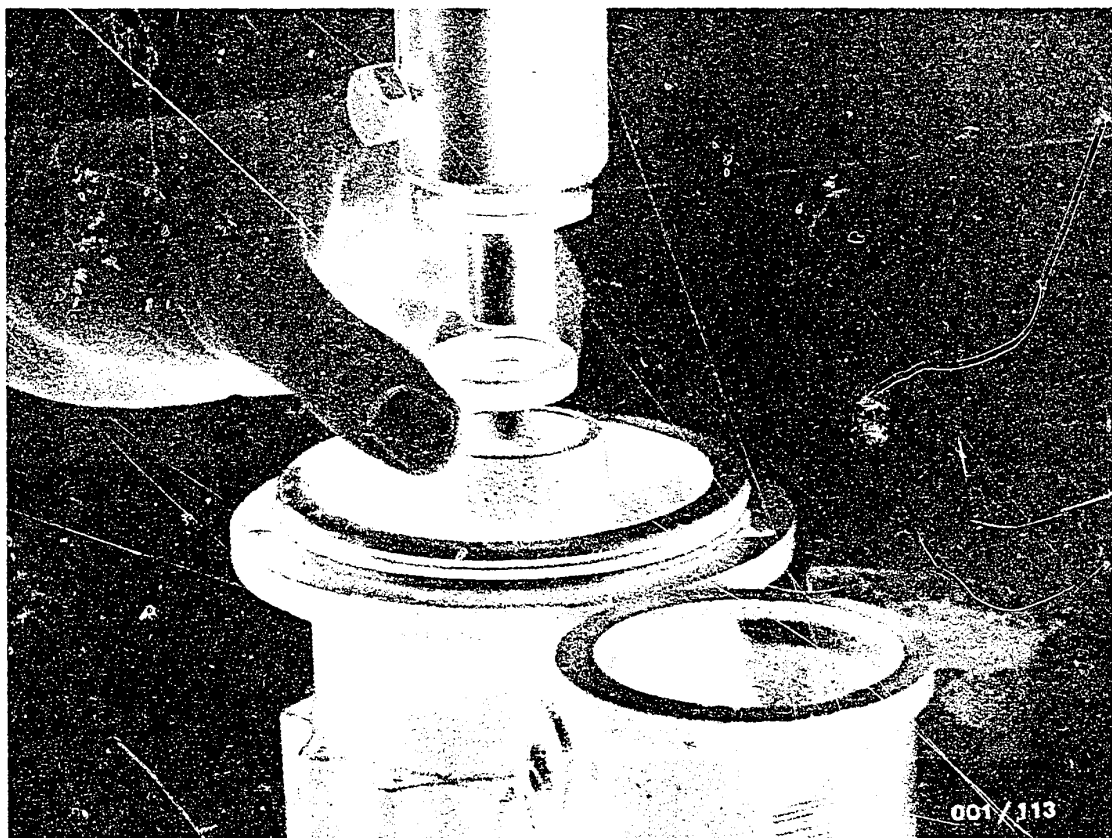

Installing the needle bushing and radial-lip-type oil seal - intermediate bearing

Fit the needle bushing onto the press-in mandrel KDAL 5040 and press in until the tool comes up against the intermediate bearing.

Lightly grease the outside of the radial-lip-type oil seal with special lubricating grease 5 932 240 150 and press in using press-in tool KDAL 5041 until the tool comes up against the intermediate bearing (Sealing lip must point towards needle bushing (see illustration)).

C2

Examination and repair

KE Stg.motors 0 001 420 ..., 0 001 421 ...

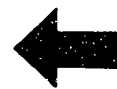

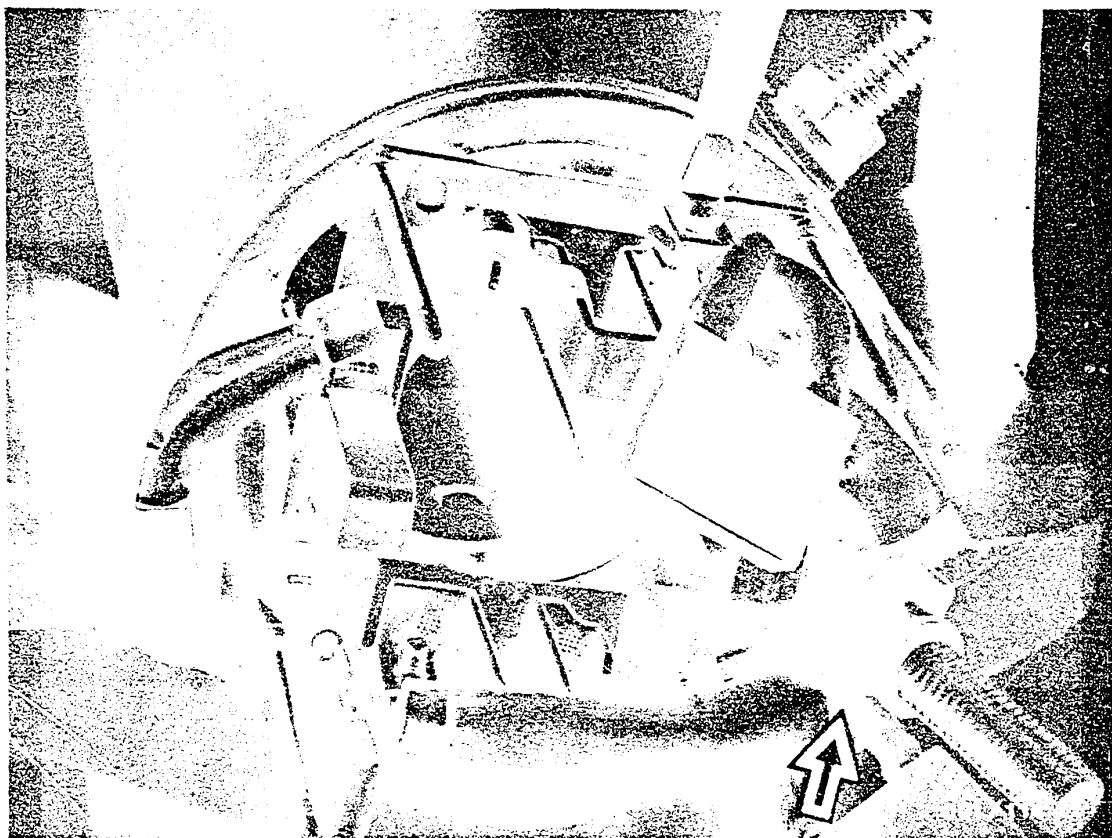

11. Assembling the starting motor

11.1 Fitting the brush holder

Clamp the stator frame in the clamping support.
Fasten the brush holder with threaded pin.
Tighten the threaded pin to a tightening torque of 4.1 - 5.5 Nm with 2 locked nuts.

Screw down the carbon brushes, excitation winding and electric lead.

(Pay attention to the correct installation position of the electric lead with pin term. 31 (see illustration, arrow)).



11.2 Installing the armature

Lightly grease the wedge section and the gear running surface of the armature shaft over its entire length with special lubricating grease 5 932 240 150 (approx. 3 grammes).

Pack the centre of both shaft ends to the brim with special lubricating grease 5 932 240 150.

Lightly oil all other bright parts with anti-corrosion oil 5 701 351 610.

Keep the commutator free of oil and grease.

Slide armature into stator frame.

C4

Assembling the starting motor

KE Stg. motors 0 001 420 ..., 0 001 421 ...





11.3 Fitting the intermediate bearing

Lightly grease the O-ring with special lubricating grease 5 932 240 150.

Screw down the intermediate bearing together with new needle-roller bearing, radial seal and O-ring.

Tightening torque: 10.2 - 13.6 Nm



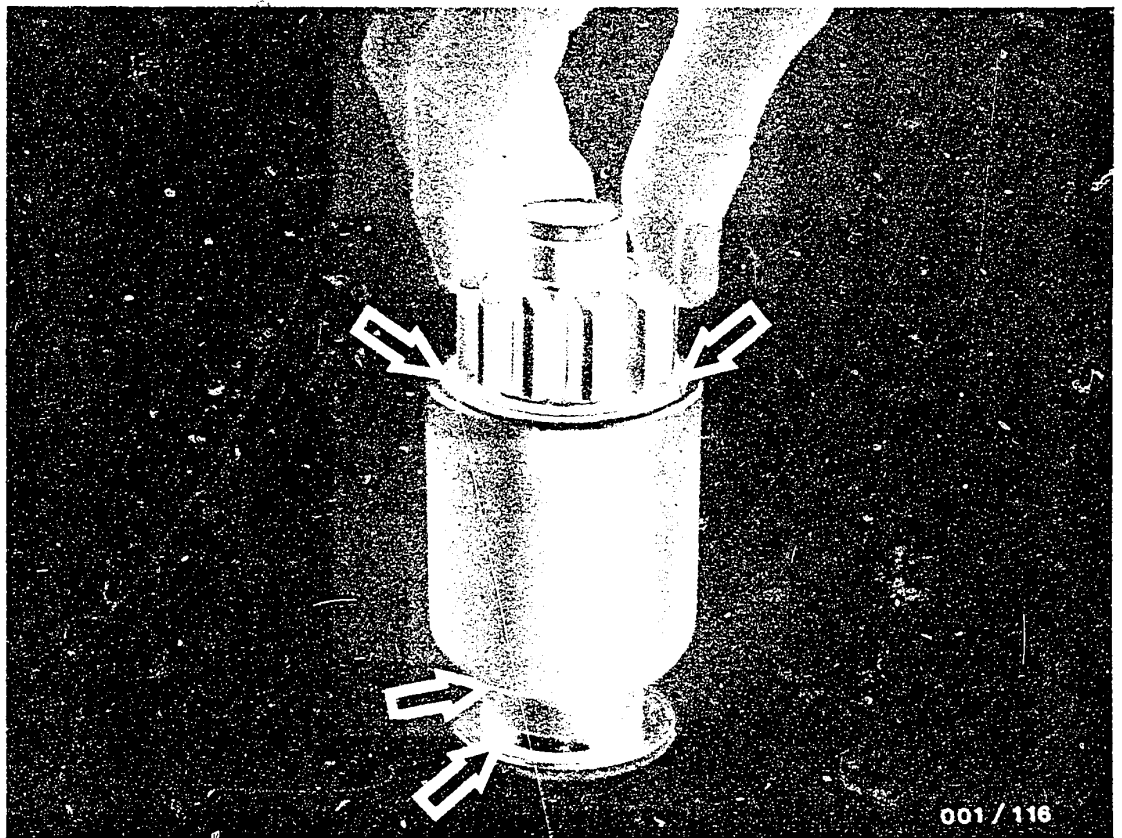

11.4 Installing the overrunning-clutch drive

Check the friction washer (intermediate bearing/plastic) for damage, and replace if necessary, and slip onto armature shaft.

Apply special lubricating grease 5 932 240 150 to both sides of the groove (0.75 grammes each side) for the fork lever pin on the overrunning-clutch drive (see illustration, bottom arrows).

Fill space between housing and pinion shaft (see illustration, top arrows) with silicone oil 5 962 260 605 and force back pinion as far as it will go.

C6

Assembling the starting motor

KE Stg.motors 0 001 420 ..., 0 001 421 ...



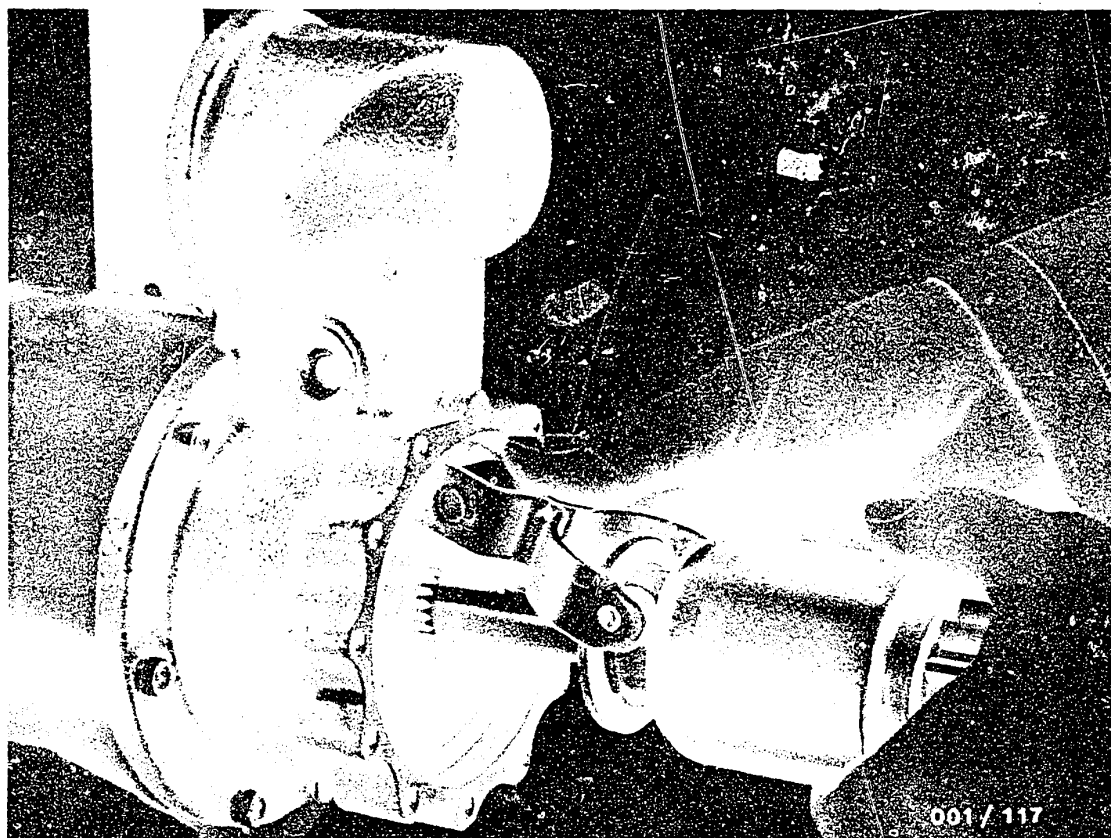

Lightly grease the fork lever pin with special lubricating grease 5 932 240 150.

Slip the overrunning-clutch drive together with fork lever onto armature shaft (see illustration).

Lightly grease the fork lever mounting with special lubricating grease 5 932 240 150 (0.5 grammes) and install. (Use new nut and flat seal ring).

Tightening torque: 12 - 16 Nm

Slip the friction washer (drive-end-bearing housing/steel) onto the armature shaft.

C7

Assembling the starting motor

KE Stg.motors 0 001 420 ..., 0 001 421 ...



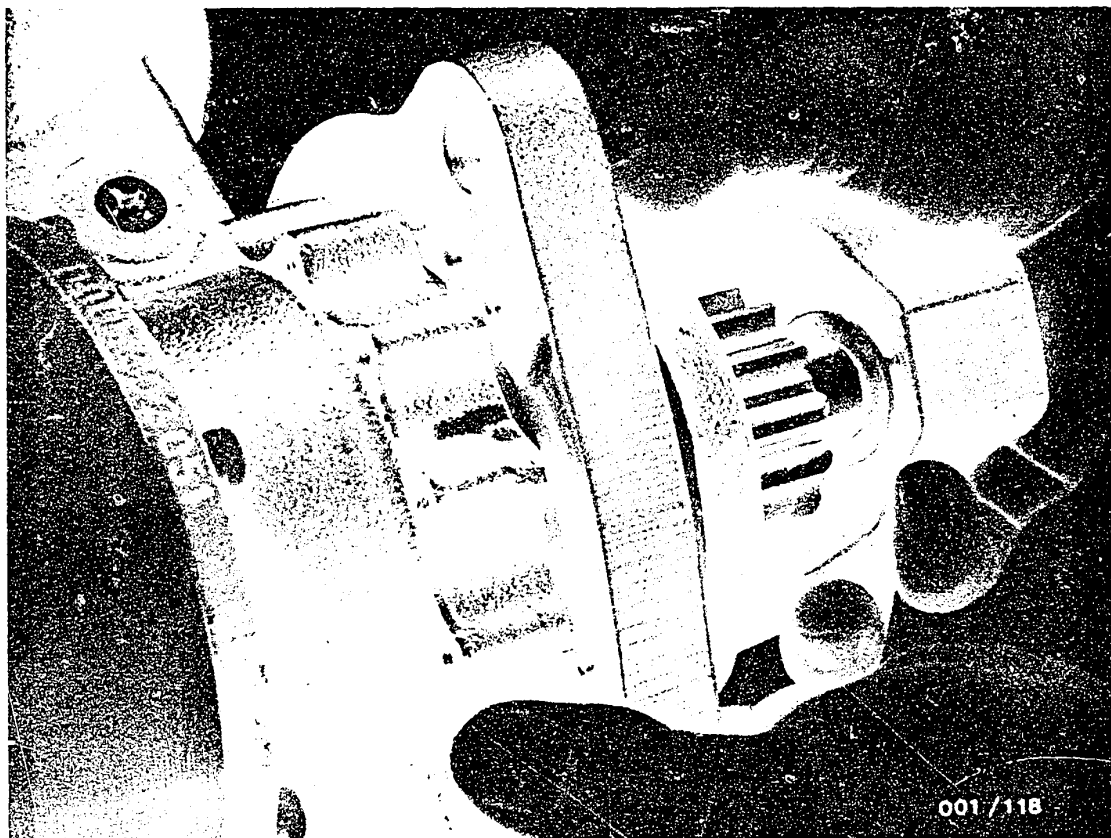

11.5 Installing the drive-end-bearing housing

Lightly grease the O-ring with special lubricating grease 5 932 240 150.

Fit the drive-end-bearing housing together with new O-ring and new needle bushing onto the intermediate bearing.

Ensure the correct position of the drive-end-bearing housing/intermediate bearing (marking).

Tightening torque of hexagon-socket-head cap screws:
10.2 - 13.6 Nm

C8

Assembling the starting motor

KE Stg.motors 0 001 420 ..., 0 001 421 ...



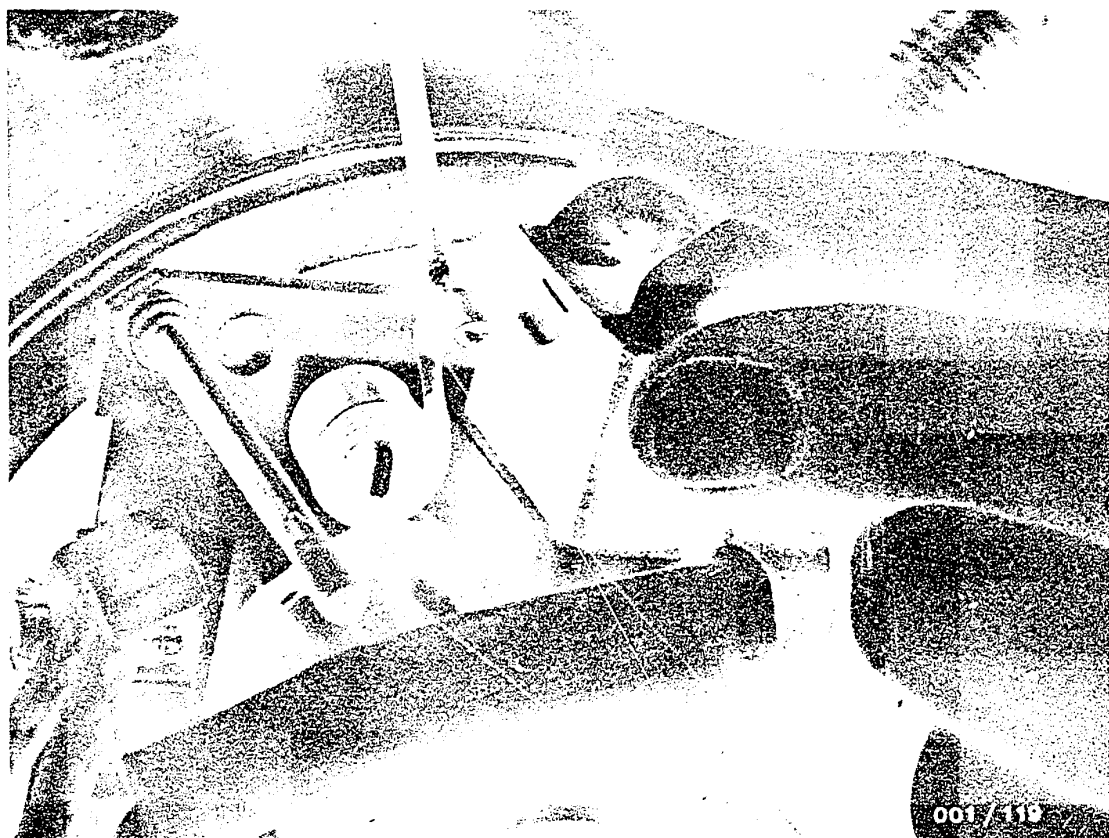

11.6 Fitting the carbon brushes

Raise the springs with a suitable hook and fit the carbon brushes.

Minimum carbon brush length: 17.5 mm

Brush pressure with new
carbon brushes 47 ... 53 Nm

C9

Assembling the starting motor

KE Stg. motors 0 001 420 ..., 0 001 421 ...



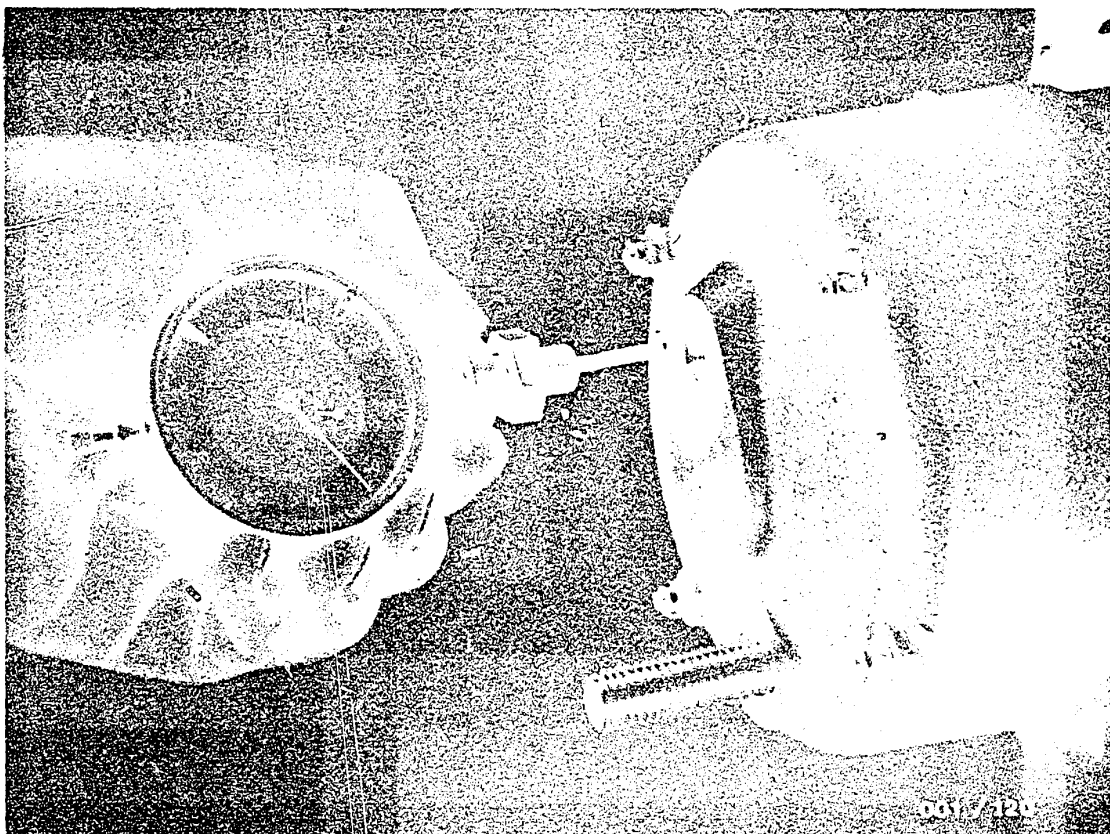

11.7 Adjusting the armature longitudinal clearance
(Only commutator end shield without screw plug, see illustration)

Remove the O-ring from the stator frame (commutator end).

Fit the commutator end shield with old needle bushing.
(Use old nuts).

Pay attention to installation position of pin term. 31
(fit in plastic guide).

If installing a new commutator end shield without needle bushing, use bearing bushing (KDAL 5045) instead of the needle bushing in order to guide the armature shaft. Screw the dial indicator with measuring insert and measuring tool into the thread for the test fitting of the commutator end shield (see illustration).



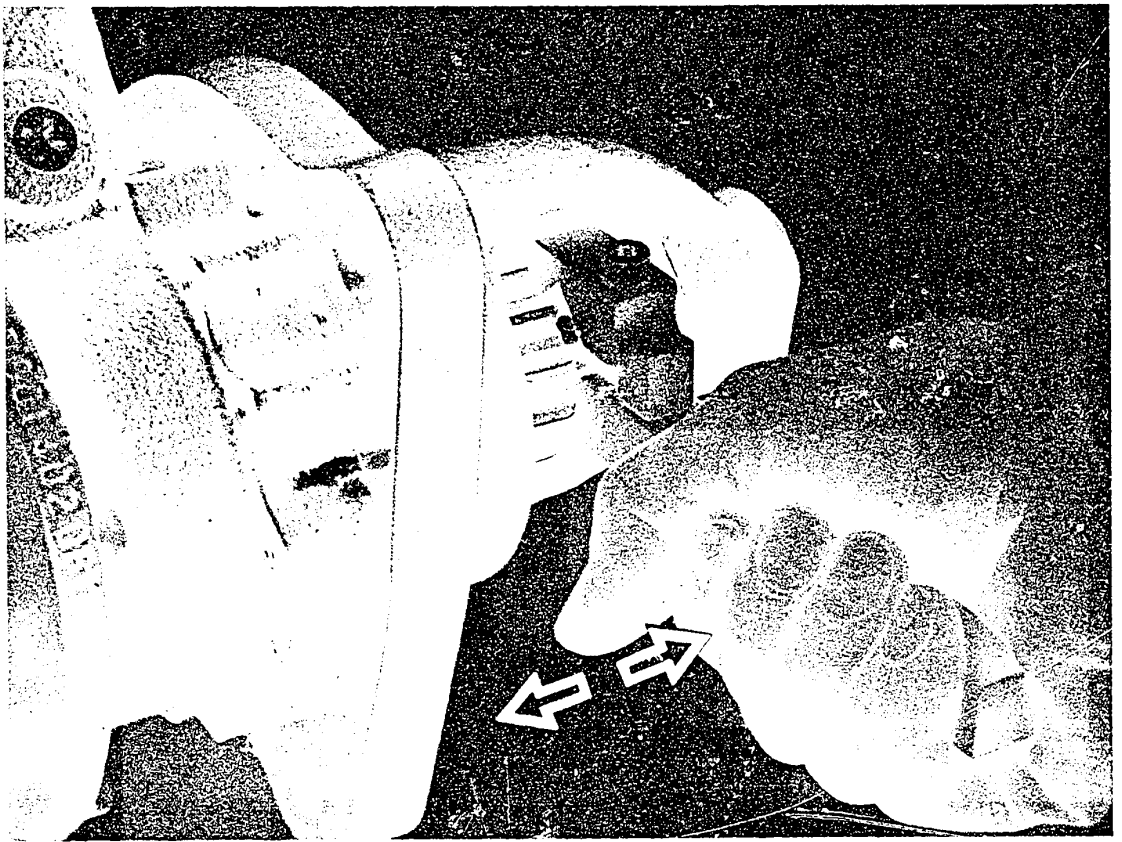

Screw the holding tool KDAL 5036 onto the armature shaft (drive-end-bearing housing end).

Measure the armature longitudinal clearance on the dial indicator by moving the armature shaft (shaft must not turn).

Armature shaft must be clearly heard to come up against the shim plates of the drive-end-bearing housing/commutator end shield.

Armature longitudinal clearance should be 0.1 - 0.4 mm.

C11

Assembling the starting motor

KE Stg. motors 0 001 420 ..., 0 001 421 ...



Remove the dial indicator.
Unscrew the commutator end shield.
Remove the needle bushing with KDAL 5492, or remove the bearing bushing (KDAL 5045).

If the armature longitudinal clearance is outside tolerance, remove the shim plate(commutator end) and measure.

The armature longitudinal clearance can be adjusted with 4 different shim plates:

2.0 mm

2.2 mm

2.5 mm

2.8 mm

Example: Armature longitudinal clearance: 0.6 mm.
Old shim plate: 2.5 mm

By using a shim plate of 2.8 mm the longitudinal clearance is reduced to 0.3 mm.

Fit new needle bushing onto KDAL 5039 (lettering on needle bushing must point upward toward press-in tool) and press in until tool comes up against commutator end shield.



Slip new O-ring onto stator frame (commutator end) and pin term. 31 (electric lead) and grease lightly with special lubricating grease 5 932 240 150 (pay attention to installation position of term. 31).

Install the commutator end shield.
(Use new seals and new nuts).

Tightening torque for nut M 5: 4.1 - 5.5 Nm

Tightening torque for nut M13: 24 - 26 Nm

Check armature longitudinal clearance again (should be 0.1 - 0.4 mm).

C13

Assembling the starting motor

KE Stg. motors 0 001 420 ..., 0 001 421 ...



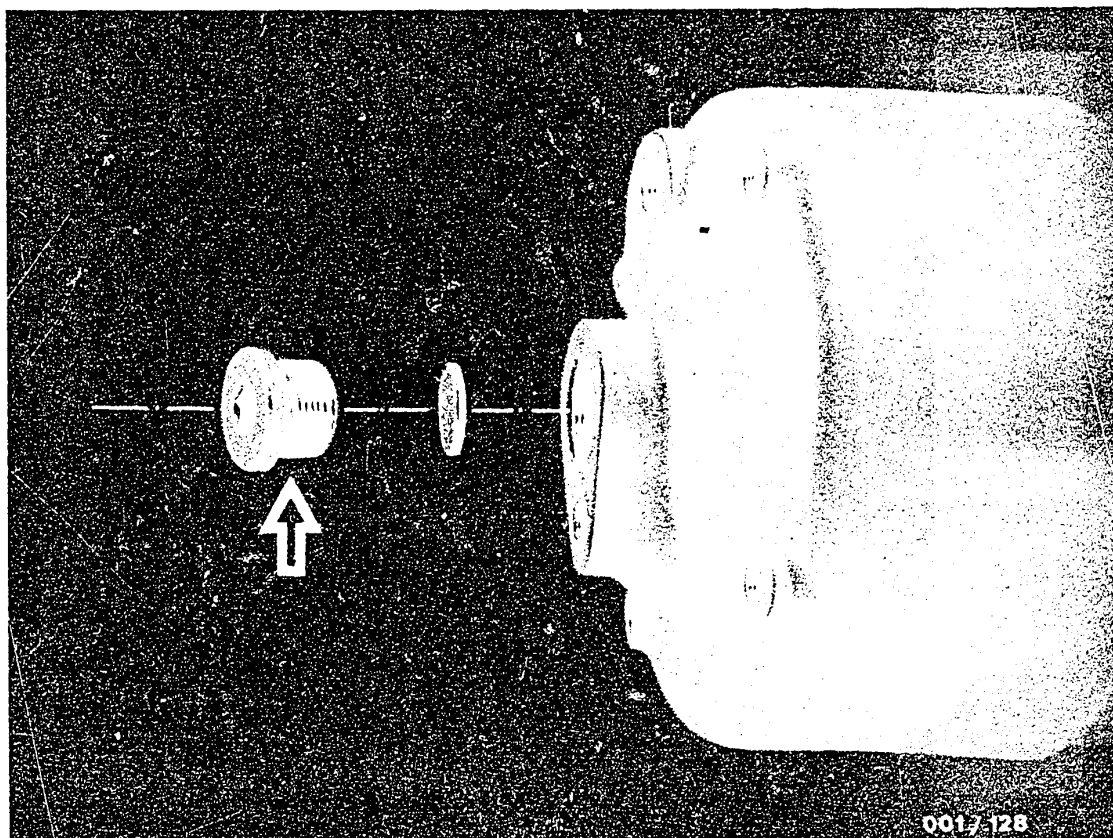

11.7.1 Adjusting the armature longitudinal clearance (Commutator end shield with screw plug)

In more recent versions of starting motor and for when the starting motor has to be replaced, the commutator end shield has been provided with an additional bore with screw plug (see illustration, arrow). By means of this bore the armature longitudinal clearance is measured and adjusted with shim plates of different thickness.

Unscrew the screw plug and scrap (may only be used once).

C14

Examination and repair

KE Stg. motors 0 001 420 ..., 0 001 421 ...



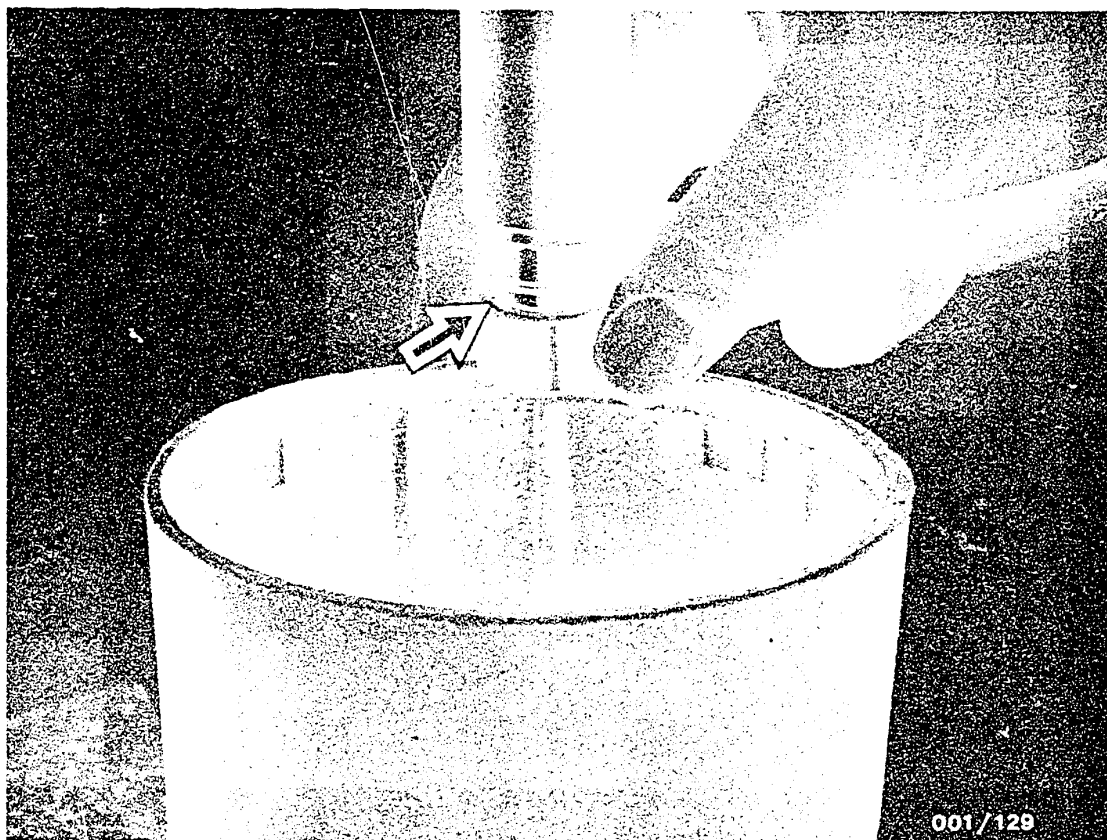

Before adjusting the armature longitudinal clearance, install a new needle bushing. Force the old needle bushing out of the commutator end shield from outside using press-out mandrel KDAL 5038.

Fit new needle bushing onto KDAL 5039. (Lettering on needle bushing must point upward to press-in tool, illustration, arrow) and press in as far as the tool will go.

Insert new O-ring into stator frame (commutator end) and on pin term. 31. Grease O-rings lightly with special lubricating grease 5 932 240 150.

Install commutator end shield, paying attention to the installation position of term. 31. Fit in plastic guide.

Use new copper seals and self-locking nuts. Install electric lead (thin, black) term. 31 to relay.

Tightening torque for nut M 5: 4.1...5.5 Nm

Tightening torque for nut M13: 24...26 Nm

C15

Examination and repair

KE Stg.motors 0 001 420 ..., 0 001 421 ...



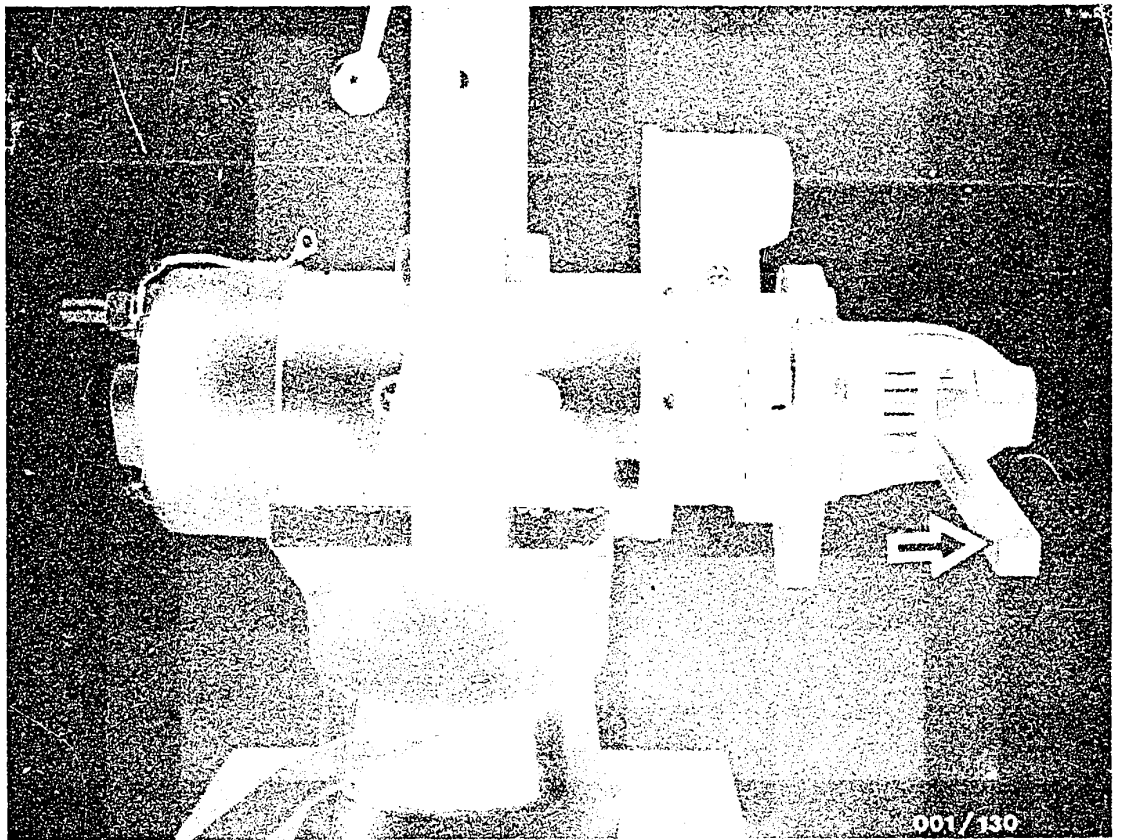

Fit the holding tool KDAL 5036 (see illustration). Slide the armature as far as it will go (drive end) (illustration, arrow). Armature shaft must be heard to come up against the shim plate in the drive-end-bearing housing.

C16

Examination and repair

KE Stg.motors 0 001 420 ...,0 001 421 ...



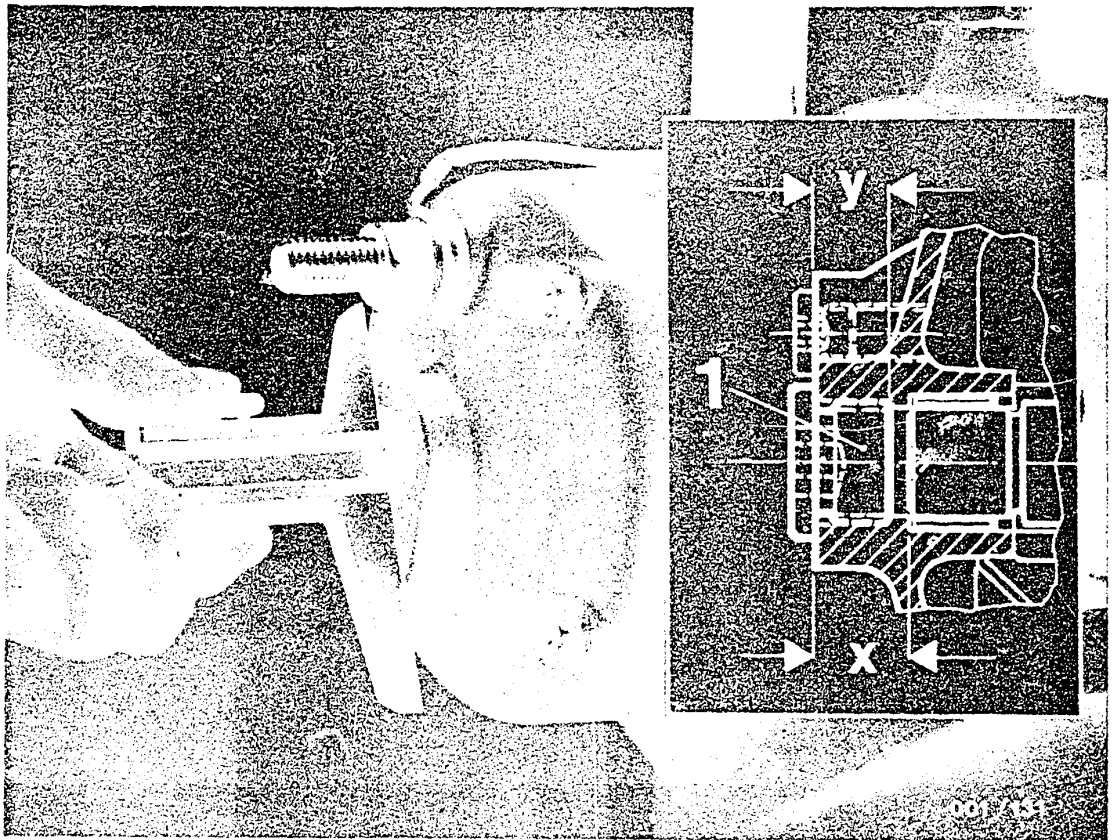

Using a caliper gauge or depth gauge, measure dimension x between the armature shaft and the end face of the commutator end shield. Do not measure into the middle of the armature shaft.

Measure the screw-in length of the screw plug (1) = Dimension y.

Calculate difference (x - y).

Example: Dimension x = 16.05 mm

Dimension y = 13.95 mm

Difference = 2.1 mm

Armature longitudinal clearance should be 0.1...0.3 mm



The armature longitudinal clearance can be adjusted with 6 shim plates of different thickness:

1.5 mm
1.7 mm
1.9 mm
2.1 mm
2.3 mm
2.5 mm

Example: Difference	2.1 mm
Shim plate	1.9 mm
Armature longitudinal clearance	<hr/> 0.2 mm (should be 0.1... 0.3 mm)

Insert appropriate shim plate into opening on commutator end shield.

Screw in new micro-encapsulated screw plug and tighten to 45...55 Nm.

Note: Threads on screw plug and commutator end shield must be free of oil and grease. Micro-encapsulated screw plug must be screwed in once only; micro-encapsulation (locking) effect is lost if screw plug is screwed in again.



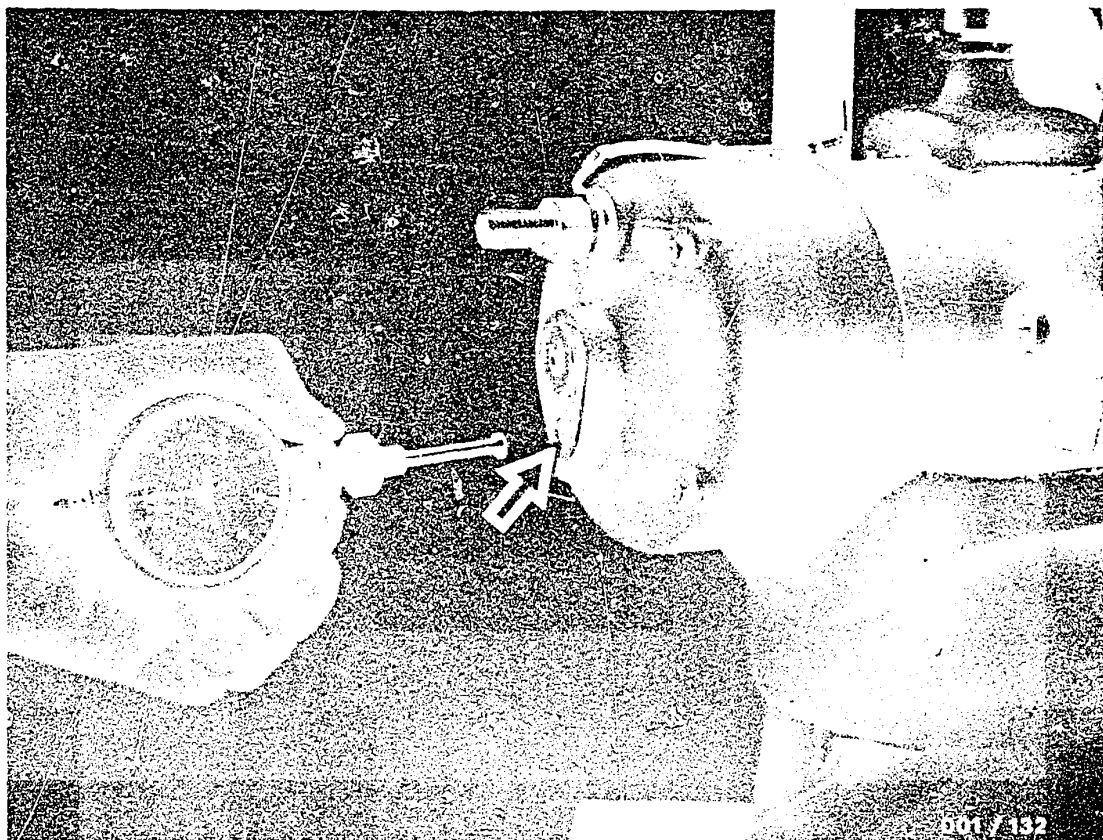

11.7.2 Checking the armature longitudinal clearance

Screw the dial indicator with measuring tool KDAL 5037 into the thread for test fitting on the commutator end shield (see illustration). Using holding tool KDAL 5036, move the armature shaft in a longitudinal direction. Armature shaft must be heard to come up against shim plate.

Armature longitudinal clearance should be 0.1...0.3 mm (read off on dial indicator). If armature longitudinal clearance is outside tolerance, repeat the previously described adjustment of the armature longitudinal clearance.

Remove dial indicator with measuring tool and holding tool.



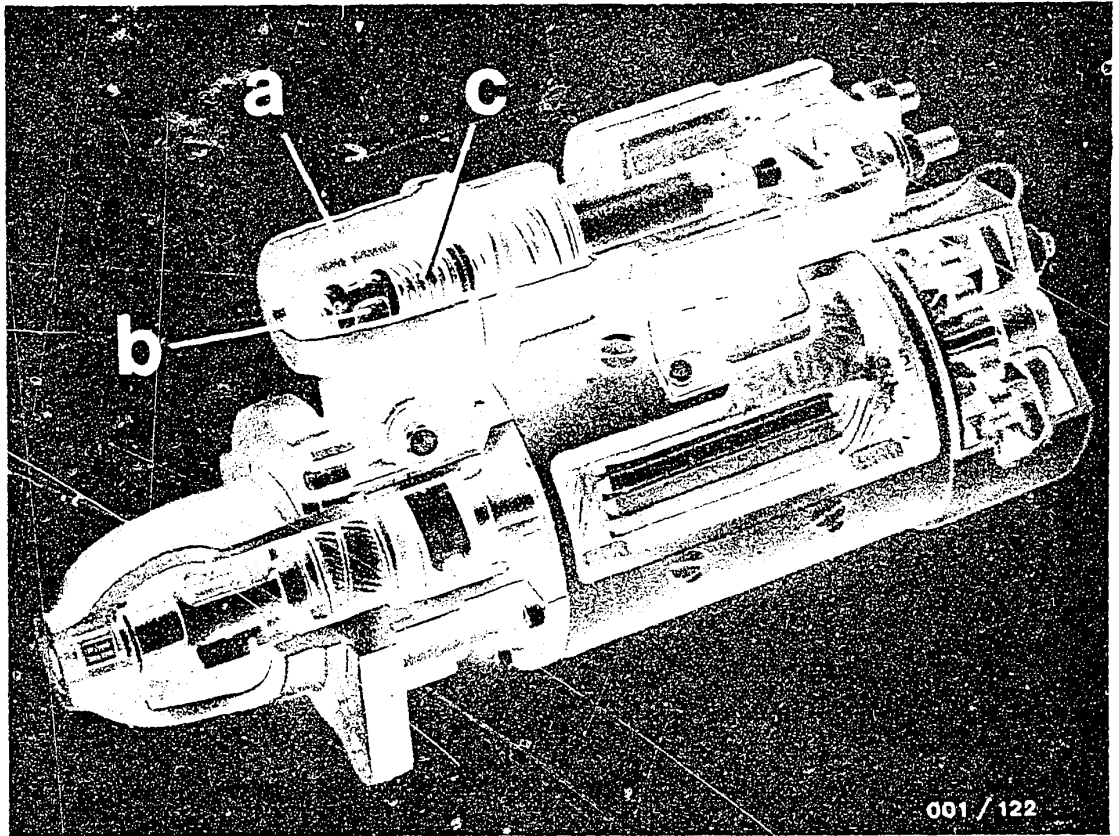

001 / 122

- a = Thread roller
- b = Fork lever
- c = Armature shaft

11.8 Installing the solenoid switch

Lightly grease the thread roller (a) with special lubricating grease 5 932 240 150 (0.5 grammes).

Lightly oil the armature shaft (c) with anti-corrosion oil 5 701 351 000 (0.2 grammes).
Use a new seal.

C20

Assembling the starting motor

KE Stg.motors 0 001 420 ..., 0 001 421 ...



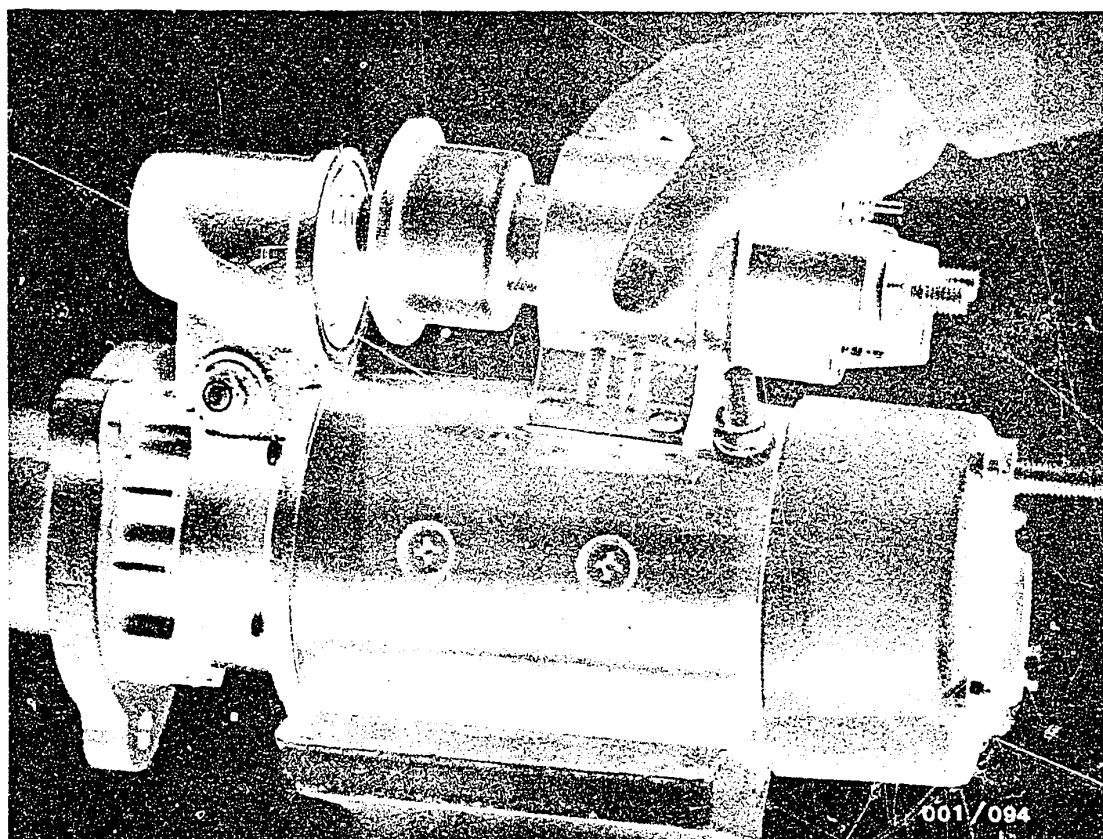

Hook the solenoid switch into the fork lever from above (see illustration) and fasten with 4 new micro-encapsulated bolts so that the plain washers can still be moved.

C21

Assembling the starting motor

KE Stg.motors 0 001 420 ...,0 001 421 ...



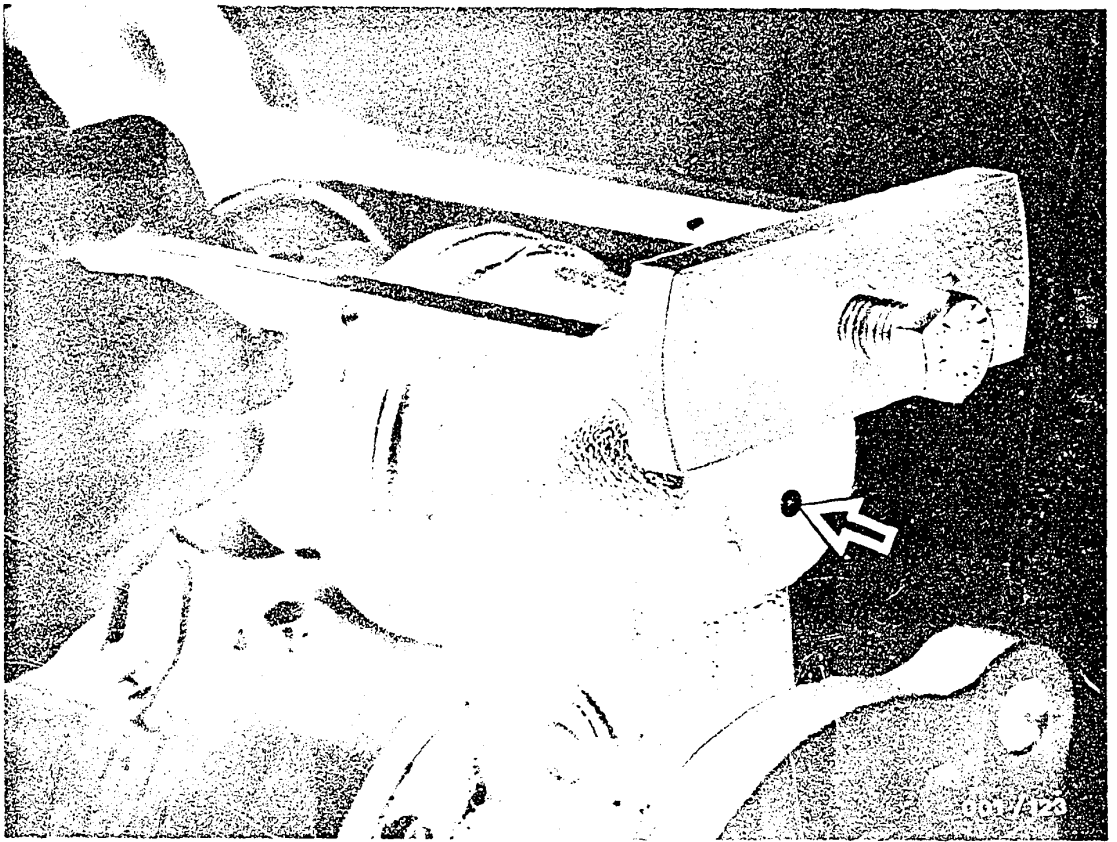

Mount clamping fixture KDAL 5042 and tighten lightly.

The tip of the clamping screw must lie in the centering point of the solenoid-switch dome (arrow).

C22

Assembling the starting motor

KE Stg.motors 0 001 420 ...,0 001 421 ...



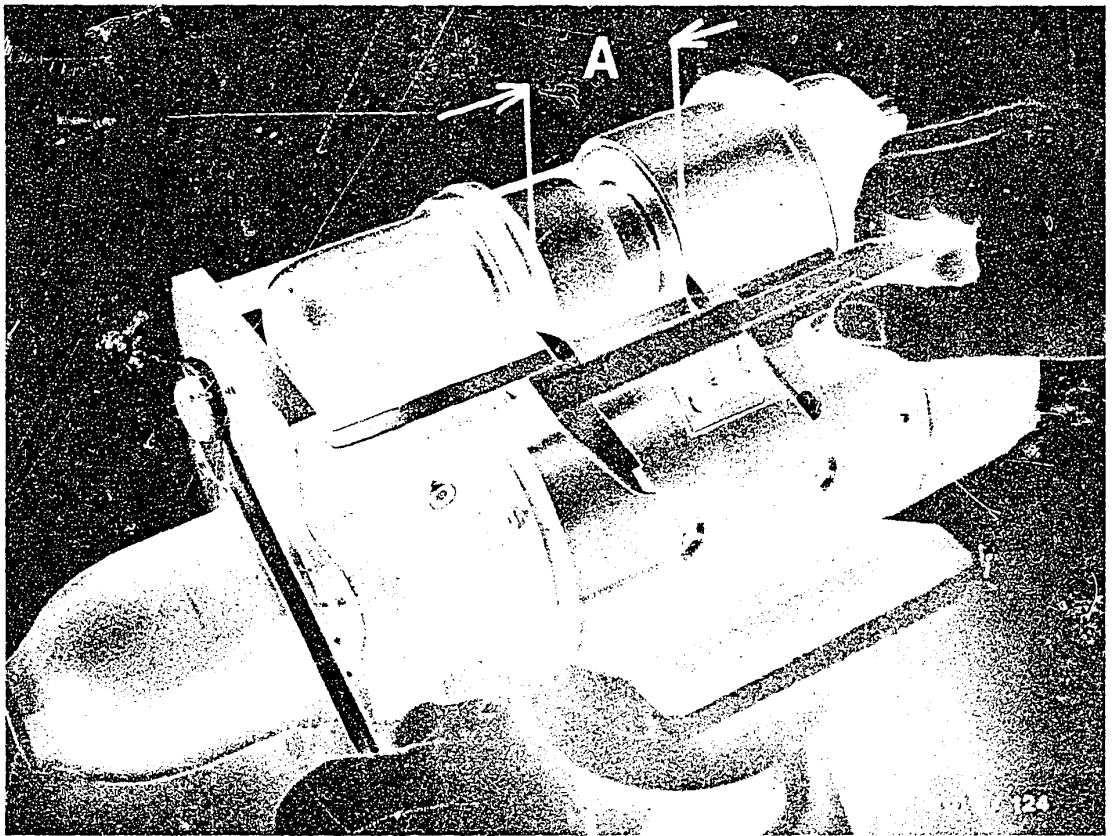

Using clamping fixture KDAL 5042, adjust dimension A (distance between solenoid switch mounting bracket and solenoid-switch dome) to

$$62.5 \begin{matrix} + 0.2 \\ - 0.5 \end{matrix} \text{ mm.}$$

Tighten solenoid switch fastening screws to 7.2 - 9.7 Nm.

Remove clamping fixture.

Install bus bar.

Tightening torque for both nuts: 24 - 26 Nm.

Install electric lead term. 31.

Tightening torque term. 31 solenoid switch:	4 - 5 Nm
term. 31 commutator end shield:	24 -26 Nm

C23

Assembling the starting motor

KE Stg.motors 0 001 420 ...,0 001 421 ...



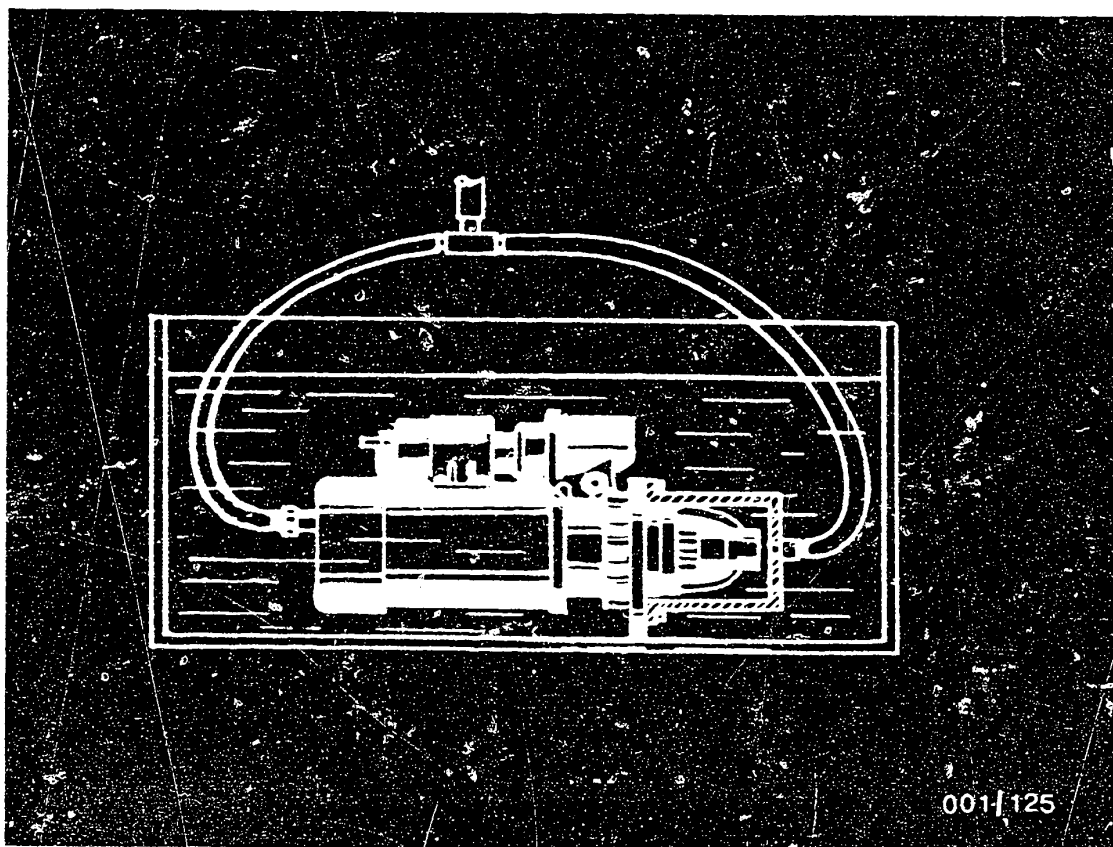

12. Leak test

Screw the test fitting (KDAL 5043) with flat seal ring and compressed-air line into the opening on the commutator end shield.

Seal off the starting motor on the drive-end-bearing housing end with cap KDAL 5043. Connect compressed-air lines with "T-piece".

Test pressure: 0.2 bar
Test duration: 30 seconds

The starting motor must be completely under water.
(See illustration).

No air bubbles must be visible.

After testing, carefully seal the opening for the test fitting with bolt and seal.

Tightening torque: 5 - 6.4 Nm

D1

Leak test

KE Stg.motors 0 001 420 ..., 0 001 421 ...



13. Testing on the test bench

13.1 General

The following test benches may be used

- EFAL 140 In conjunction with clamping flange KDAL
5046 for 12 V and 24 V starting motors
- EFAL 152 Not suitable for the short-circuit test on
153 12 V starting motors (current consumption
max. 2500 A).

Correctly clamp the starting motor on the test bench. Connect the positive and negative cables of the test bench to the starting motor. Tighten the electric connections (terminal studs) properly.

The electrical test specifications depend on the condition of the battery (capacity and state of charge) and on the test duration (heating up of starting motor, discharging of battery). The test specifications apply only to the test bench and cannot be used for starting motors which are fitted to the engine or installed in the vehicle. A small starting motor is more heavily loaded by the battery installed in the test bench whereas the capacity of the test-bench battery is not sufficient with the largest types of starting motor to get maximum power from them. The power of the starting motor is likewise influenced by the unavoidably longer cables in the test bench. The test duration should, therefore, be as short as possible and the battery should be in good condition and at least three-quarters charged.

With defective starting motors the measured values differ considerably from the stated test specifications. In this case, dismantle the starting motor again and repeat the tests on the individual components.



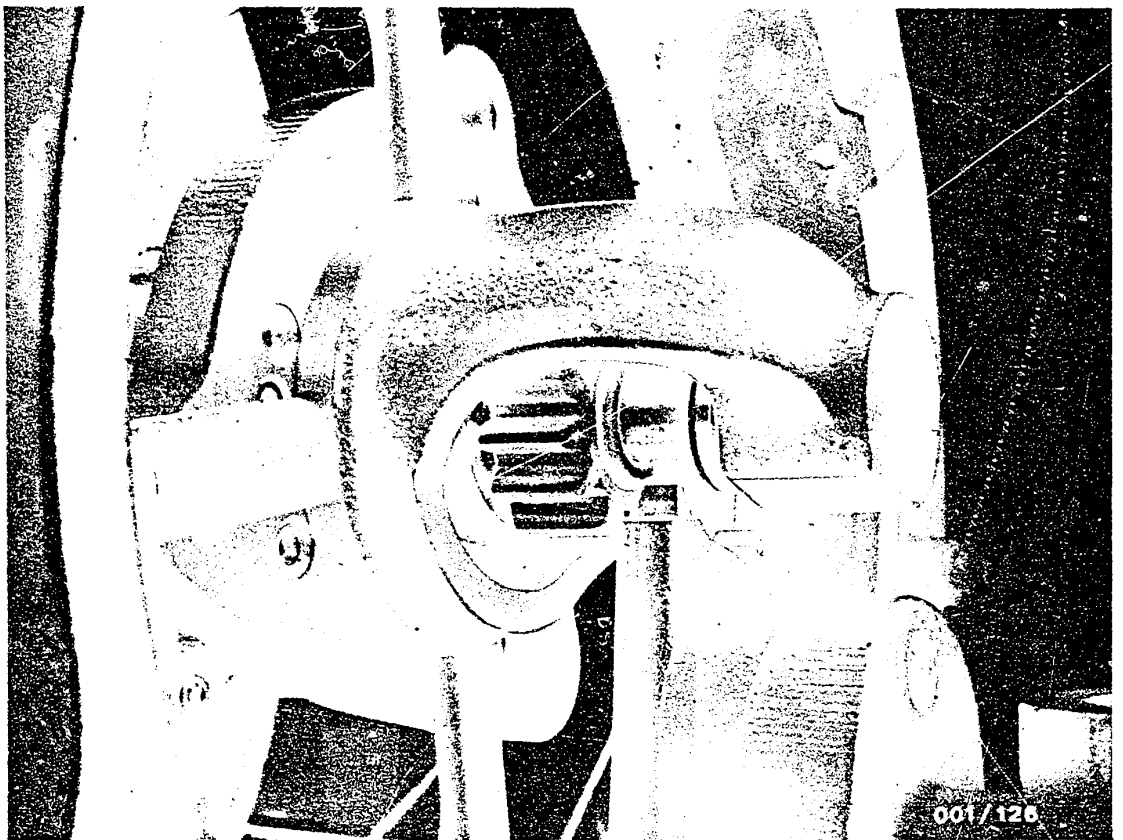

13.2 Minimum pull-in voltage for solenoid switch
(Mounted on starting motor)

At the stated voltages the overrunning-clutch drive must be moved completely forward (in the direction of the drive-end-bearing housing) (illustration).

Minimum voltage with tooth/tooth connection:

24 V solenoid switch: ≤ 16 V

12 V solenoid switch: ≤ 8 V

D3

Testing on the test bench

KE Stg.motors 0 001 420 ..., 0 001 421 ...



13.3 No-load and short-circuit tests

The test specifications are based on 2 x 12 V 143 Ah batteries 3/4 charged, series-connected for 24 V starting motors, parallel-connected for 12 V starting motors.

<u>No-load test</u>	<u>V</u>	<u>< A</u>	<u>> min⁻¹</u>
0 001 420 ...	24	140	5500
. ... 421 001	12	200	5500

Short-circuit test

For the short-circuit test the ring gear or gear segment of the test bench and of the starting-motor pinion must have the same module (teeth); if not, exchange the ring gear of the test bench or set a different gear segment.

<u>Starting motor</u>	<u>Module</u>
0 001 420 001	3.175
002	3.175
003	4.233
004	3.175
0 001 421 001	3.175

D4

Testing on the test bench

KE Stg. motors 0 001 420 ..., 0 001 421...



13.4 Backlash

The backlash is the clearance (play) between the tooth flanks of the meshed pinion and those of the ring gear/ gear segment.

To make the measurement, mesh the pinion by hand and hold in place, or push the starting motor forward; test the backlash with a feeler gauge. (Not possible if starting motor installed in vehicle)

If play is too small or too great, this leads to heavy wear on the teeth and can even mean that entire teeth are broken off.

Backlash 0.6 ... 0.9 mm

D5

Testing on the test bench

KE Stg.motors 0 001 420 ...,0 001 421 ...



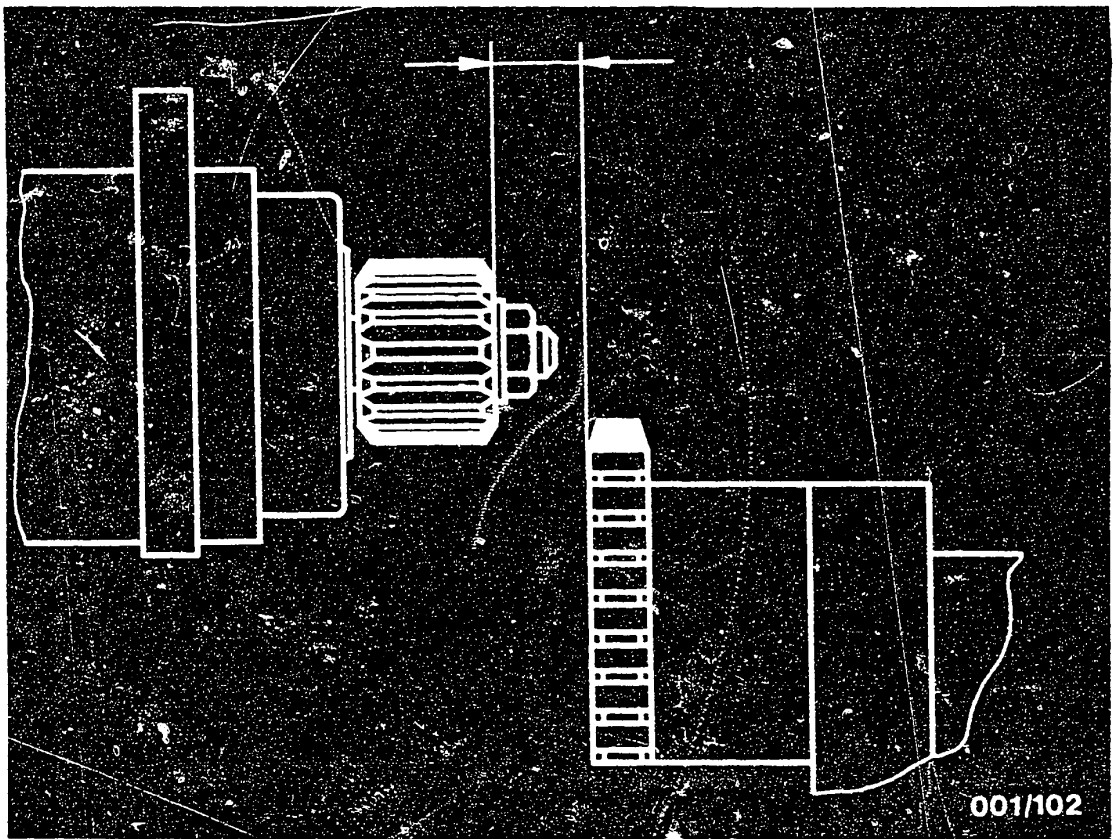

13.5 Pinion clearance

The pinion clearance is the clearance between the ring gear and the end face of the pinion when the starting motor is in the rest position.

If the clearance is too great, the pinion does not mesh far enough into the ring gear; pinion teeth and ring-gear teeth have insufficient contact area and, thus, they are subjected to heavy one-sided loading. The minimum clearance is necessary so that the pinion is certain to demesh, so that in the event of strong vibrations it does not hit against the rotating ring gear and also so that it cannot mesh in so far that the pinion shaft is up against the ring gear.

Pinion clearance

3.0 ... 4.0 mm

D6

Testing on the test bench

KE Stg.motors 0 001 420 ... ,0 001 421 ...



13.6 Test procedure

Set the measuring-range selector switch.

On test benches with toothed gear/ring gear, switch on the starting motor and brake until it comes to a stop. Read off the test specifications. Carry out the test only for a short time, maximum of 1 to 2 seconds.

On test benches with a fixed gear segment, switch on the starting motor briefly and read off the test specifications.

The following table gives the short-circuit test specifications.

Starting motor	V	A	Torque
0 001 420 ...	9	<1400	>110 Nm
0 001 421 ...	4.5	<2000	> 80 Nm
(With 2 batteries 12V 143 Ah connected in parallel)	5.8	<2600	>110 Nm

D7

Testing on the test bench

KE Stg.motors 0 001 420 ...,0 001 421 ...



After-sales Service

Technical Bulletin

Only for use within the Bosch organization. Not to be communicated to any third party.

Change in starting motor marking
New performance designation for starting motors
(kW instead of HP)

00

VDT-I-001/111 B
Ed. 1 12.1975
Translation of German
edition of 3.11.1975

Conversion of performance data

According to West German law all performance data must be converted to the International System of Units (SI) by December 31st 1977. Consequently the HP (PS) value given on Bosch starting motors must be converted into kW. At the same time the previous definition of starting motor performance will be revised. Previous HP values were "nominal power"; the new kW values will represent "maximum power", with reference to the maximum permitted battery size. Thus a straightforward conversion of the old HP values into kW (1 HP = 0.735 kW) is not possible.

After-sales service notes

This conversion is of little relevance for after-sales service, since as from about September 1975 newly-developed Bosch starting motors have not been marked with a performance figure. The conversion for the already-existing starting motor program is intended to take place step-by-step up to the end of 1975. After this the marking will generally comprise only the part number and underneath it the direction-of-rotation arrow and the voltage. The type letters, e.g. EF, JD etc., and the HP value will have disappeared.

Present:

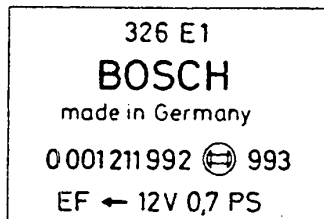

Future:

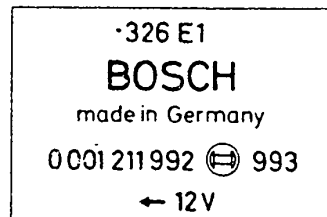

This also renders it unnecessary to give the kW performance in the test specification sheets VDT-WPE 510/... The first 7 figures of the part number are sufficient information for establishing the nominal values.

A cross-reference between the new and old type designations can be taken from the main Bosch catalog "Electrical Equipment for Engines" Sheet VDT-B.6/1 (Ed. 1). In case of inquiry, please contact your authorized representative.

Published by:
After-sales Service Training Center
Automotive Equipment (KH/VSK)

BOSCH

Geschäftsbereich KH Kundendienst Kiz-Ausrüstung
© by Robert Bosch GmbH, D-7 Stuttgart 1, Postfach 50 Printed in the Federal Republic of Germany.
Imprimé en République Fédérale d'Allemagne par Robert Bosch GmbH

L1

Technical Bulletin

KE Stg.motors 0 001 420..., 0 001 421...



After-sales Service

Technical Bulletin

Only for use within the Bosch organization. Not to be communicated to any third party.

SCREWDRIVER BLADE FOR POLE-SHOE SCREWS
WITH RECESSED HEAD

00
VDT-I-001/1005 En
12.1979

From the beginning of 1980 pole shoe screws in starting motors will have recessed heads. A new pole-shoe screwdriver will therefore be necessary for the clamping support.

This pole-shoe screwdriver, with a recessed-head blade size 4, can be ordered from KH/VKD 4 under the part number KDAW 9999/7.

First of all only the M 10 and M 8 pole-shoe screws will be delivered with recessed heads. These pole-shoe screws require the recessed-head blade size 4.

Recessed-head blades size 4 can be ordered from KH/ALP 2 under the part number 1 608 522 005. (They are available in packs of 2).

BOSCH

Geschäftsbereich KH Kundendienst, Kfz-Ausrüstung
© by Robert Bosch GmbH, D-7 Stuttgart 1, Postfach 50 Printed in the Federal Republic of Germany
Imprimé en République Fédérale d'Allemagne par Robert Bosch GmbH

L2

Technical Bulletin

KE Stg.motors 0 001 420 ..., 0 001 421 ...



After-sales Service

Technical Bulletin

Only for use within the Bosch organization. Not to be communicated to any third party

Parts Cleaning

Use of highly-inflammable cleaning agents, or cleaning agents which are dangerous to health

Gen.

VDT-I-Gen./18 En
7. 1978

When cleaning parts which come from vehicle electrical products prior to repair, it is permitted to use the following cleaning agents: Benzine, trichloethylene (tri) and perchloroethylene (per). These are dangerous, and must be handled with appropriate care. The relevant safety regulations in West Germany are:

Regulations concerning work with inflammable liquids (VbF) issued by the Federal Labor Ministry (BmA).

Safety regulations for the use of chlorinated hydrocarbons
as applied to the works ZH1/222
as applied to personnel ZH1/119

as issued by the Federation of the Trade co-operative Associations (Central Association for Accident Prevention and Industrial Medicine) Langartweg 103, D-5300 Bonn 5).

1. Benzine, acetone and ethanol (ethyl alcohol) are inflammable liquids and their mixtures with air are dangerous due to the risk of explosion. Parts washing may only take place in tanks or containers solely intended for this purpose and equipped with a "melt" safety device for the lid which, in case the liquid catches fire, causes the lid to close automatically and smother the fire. In the case of larger containers (exceeding 500 x 500mm) some form of suction extraction must be provided.
- 1.1 Generators, alternators, wiper motors, small-power motors and other electrical equipment for installation in vehicles are, in ever increasing numbers, being equipped with capacitors having long storage times (e.g. for interference-suppression purposes in radio-receiver or transmitter installations).

When washing such parts, it is possible that a capacitor discharge can occur when the part is immersed in the cleaning agent. This can lead to an inflammable liquid catching fire. For this reason, parts on which a capacitor is fitted are only to be washed in trichloethylene (tri) or perchloroethylene (per).

- 1.2 In the case of starting motors, it has already been pointed out in earlier repair instructions that the parts should be thoroughly dried after washing in benzine, this applies particularly to windings. With sliding-gear starting motors, the first test run after washing out must be performed without the closure cap in order to avoid the possibility of explosion.

BOSCH

Geschäftsbereich KH Kundendienst, Kfz-Ausrüstung
© by Robert Bosch GmbH, D-7 Stuttgart 1, Postfach 50 Printed in the Federal Republic of Germany
Imprimé en République Fédérale d'Allemagne par Robert Bosch GmbH.

L3

Technical Bulletin

KE Stg.motors 0 001 420..., 0 001 421...



2. Trichlorethylene (tri) and perchloroethylene (per) are both liquids whose vapors have a stupefying effect, and which are dangerous to health if inhaled over long periods. Tri vapor is heavier than air, and therefore especially dangerous at floor level. Gloves and goggles are to be worn when washing out parts in these liquids.

If cleaning of parts is carried out regularly, or continuously, in trichlorethylene only containers or tanks intended solely for this purpose are to be used, and the suction extraction device is to be switched on. When washing parts do not bend over the container.

L4

Technical Bulletin

KE Stg.motors 0 001 420..., 0 001 421 ...



After-sales Service

Technical Bulletin

Only for use within the Bosch organization. Not to be communicated to any third party.

HEALTH HAZARD DUE TO ASBESTOS DUST

VDT-I-Gen. 043 En

Note on repair

12.1981

Extractor for undercutting (commuta-
tor) saw

supersedes edition of 11.1981

Working on asbestos or products containing asbestos results in the generation of dust and minute fibers which can in the long term lead to serious damage to health.

The European Community passed a law on 28 March 1981 restricting the use of asbestos and providing for new safety regulations with regard to working with materials containing asbestos.

Note on the repair of starting motors, generators and motors

The insulation between the commutator segments of the armatures of starting motors, generators and motors still has a high asbestos content.

It is absolutely essential to extract the asbestos dust generated when undercutting this insulation with undercutting saw KDAW 9998.

As laid down in new VDI guidelines, the asbestos dust must only be extracted with an approved dirt extractor.

We therefore recommend the dirt extractor WAP-turbo M-I S-FA with the seal of approval of the German employers' liability insurance association, obtainable from

Firma Guido Oberdorfer
WAP-Maschinen
D-7919 Bellenberg
Tel. 07306/5055

BOSCH

Geschäftsbereich KH Kundendienst Kfz-Ausstattung
© by Robert Bosch GmbH, D-7 Stuttgart 1, Postfach 50 Printed in the Federal Republic of Germany.
Imprimé en République Fédérale d'Allemagne par Robert Bosch GmbH.

L5

Technical Bulletin

KE Stg.motors 0 001 420..., 0 001 421...



As an accessory for the extractor we offer the stand KDAW 9998/20 which can be used for securing the suction tube with nozzle (see sketch).

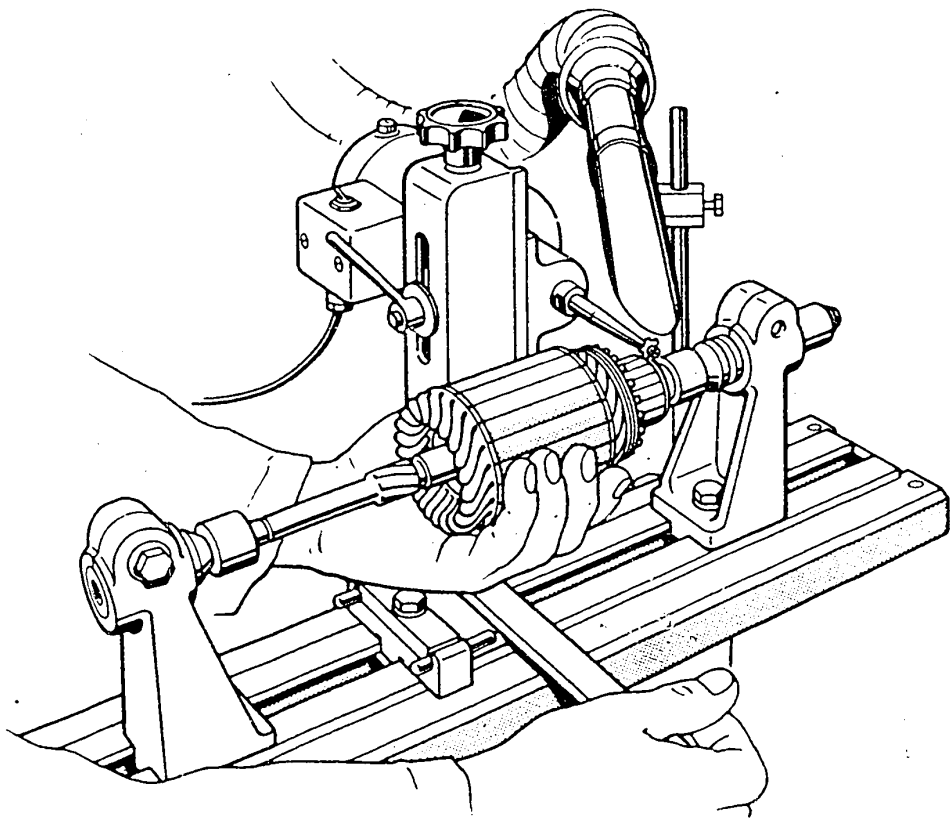

Please direct questions and comments concerning the contents to our authorized representative in your country.

L6

Technical Bulletin

KE Stg.motors 0 001 420..., 0·001 421 ...

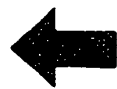

Table of contents

Section	Coordinate
Structure of microfiche	A 1
1. Electrical test specifications	A 2
2. Mechanical test specifications	A 3
3. Circuit diagram	A 4
4. General information	A 5
5. Necessary test equipment and tools	A 8
6. Lubricants	A 10
6.1 Lubrication table	A 11
7. Exploded view	A 12
8. Disassembling the starting motor	B 1
9. Cleaning the parts	B 8
10. Examination and repair	B 11
10.1 General	B 11
10.2 Testing the armature	B 12
10.3 Turning down and sawing out the commutator	B 13
10.4 Testing the true running of the armature	B 15
10.5 Testing the overrunning-clutch drive	B 16
10.6 Testing and removing the brush holder	B 17
10.7 Testing the stator frame with excitation winding (Removing/installing the excitation winding)	B 19
10.8 Testing the solenoid switch	B 22
10.9 Removing/installing the needle bushing	B 23
11. Assembling the starting motor	C 3
11.1 Fitting the brush holder	C 3
11.2 Installing the armature	C 4
11.3 Fitting the intermediate bearing	C 5



Table of contents (continued)

Coordinates

11.4	Installing the overrunning-clutch drive	C 6
11.5	Installing the drive-end-bearing housing	C 8
11.6	Fitting the carbon brushes	C 9
11.7	Adjusting the armature longitudinal clearance (only commutator end shield <u>without</u> screw plug).....	C 10
11.7.1	Adjusting the armature longitudinal clearance (commutator end shield <u>with</u> screw plug)	C 14
11.7.2	Checking the armature longitudinal clearance	C 19
11.8	Installing the solenoid switch ..	C 20
12.	Leak test	D 1
13.	Testing on the test bench	D 2
13.1	General	D 2
13.2	Minimum pull-in voltage for solenoid switch (mounted on starting motor)	D 3
13.3	No-load and short-circuit tests..	D 4
13.4	Backlash	D 5
13.5	Pinion clearance	D 6
13.6	Test procedure	D 7
	Technical Bulletin	L 1

